



MODEL NUMBER: _____

SERIAL NUMBER: _____

DATE PURCHASED: _____

OWNERS MANUAL

OF CARAVAN AIR - CONDITIONER

BELAIR
MODEL

H3200

H3400



For your safety using, please read this manual carefully before using the product.

Safety Notices

Dear user, thank you for choosing a HOUGHTON caravan air-conditioner. For your ease of use and safe maintenance we have included the following symbols in this manual:



All the contents with this “Warning” logo are about the safety of the product and the user, the user shall operate in strict compliance with the instructions.

















All the contents with this “Prohibition” logo are about the actions that shall be prohibited, or else the machine may be damaged or the user’s personal safety may be endangered.

Table of Contents

Safety Notes	1
Product Introduction	2
Packing List	3
Installation Guidance	4
Instructions for Use.....	9
Operation Instruction of the Remote Controller	10
Product Maintenance	16
Specification Parameters.....	17
Exploded Diagram and Parts List	18
Trouble Shooting Guide.....	20
Circuit Diagram	21

Safety Notes

-  Make sure the external electric supply socket of the caravan air-conditioner is effectively grounded in accordance with your local regulations. Failure to ground the unit correctly may cause electric shock or fire.
-  The caravan air-conditioner shall be switched on for electric leakage detection after installation.
-  If you are not to use the air-conditioner for a long time, please isolate the power supply.
-  Clean the filter of the air-conditioner regularly, A dirty filter will decrease air flow and lead to poor heating and cooling performance.
-  Use the remote controller to operate the air-conditioner.
-  Install the air-conditioner in compliance with the instructions of this manual ,Incorrect installation methods or alteration of the product may cause damage to the product or personal injuries to the user.
-  Be careful when installing the unit on the roof of the caravan ,crawl boards may be required.
-  There may be wires between the roof and the ceiling. When cutting into the roof, make sure the power is isolated prevent risk of electric shock .
-  Installation and maintenance of the air-conditioner must only be performed by personnel with appropriate trade qualifications and holding current licenses for such work.
-  Do not over-tighten the power connection terminals.
-  Ensure that your electrical supply and wiring is correctly sized for the power
 - demand of the air conditioner. Refer to the specification requirements of the product.
-  This appliance is not to be used by persons(including children) with reduced physical,sensory or mental capabilities,or lack of experience and knowledge, unless they have been given supervision or instruction.Children being supervised not to play with the appliance.

-  Keep the inlet and outlet of the inside and outside units of the caravan air conditioner smooth.
-  Do not spray any paint or insecticide on the surface of the air-conditioner.
-  Immediately turn off the air-conditioner and isolate power supply if there is any unusual odor,smoke or fire detected, Contact after-sales-service personnel in case of unit fault and fire.

Product Introduction

A. Purpose

HOUGHTON BELAIRE is designed to provide a comfortable environment inside a recreational vehicle or caravan.

B. How to provide an efficient operation

Many factors will affect the total heat load within the caravan and many factors can also affect the working efficiency of the air-conditioner. Before purchasing HOUGHTON BELAIRE, the user shall consult with the caravan manufacturer to understand the total heat load of the caravan and to choose the correct air-conditioner for the application.

The following measures are very useful to reduce the heat load within a caravan or RV and improve the performance of the air-conditioner.

- Close all the doors, skylights and windows, draw the curtains and open the sunshade.
- Adjust the caravan's position to make sure the sunshade is on the southern side in the northern hemisphere or on the northern side in the southern hemisphere. This will reduce the exposure to direct sunshine.
- Turn off the unnecessary electrical appliances within the caravan to reduce the heat-load.
- Please cook outside of the caravan.
- Park the caravan at a shade place.
- In case of exceptional high temperature, turn on the air-conditioner in advance during the morning.
- Adjust the set temperature of the remote control to prevent from frequent start or stop of the unit.

C. Condensation

For the areas where the air humidity is comparatively low, when the warm moist air within the caravan meets with the cold wind from the outlet, condensate water may be caused, which is also called as "sweating". In this case, make sure the following measures are taken:

- Close all the doors, skylights, windows and draw the curtains to reduce the warm moist air incoming.
- In the operation of the air-conditioner, a large number of condensate water will be produced on the roof as the warm moist air is exhausted by the operation of the air-conditioner. The size of the condensate water is decided by the air humidity. In this case, do not adjust the wind FAN to low or auto mode but adjust it to high FAN mode to increase the circulation of the air and reduce the condensation degree.

Please be noted that losses caused by the condensate water are not within warranty scope.

D. Choosing and using of generator

- HOUGHTON BELAIRE requires an AC power source and may require for generator driving in some remote areas. Requirements for generator include: efficient power source, stable currency, output waveform: sine wave, that shall meet the driving requirements of the compressor. The user shall consult with the generator supply and fully refer to their suggestions.

Please be noted that losses caused to the product by the using of the generator are not within warranty scope.

Packing List

Installation parts list

Main parts :

- | | |
|---|----|
| 1 . BELAIRE air- conditioner outdoor unit | ×1 |
| 2 . air inlet duct | ×1 |
| 3 . Chassis reinforced support | ×1 |
| 4 . Plenum mounting bracket | ×1 |
| 5 . Return air filter | ×1 |
| 6 . Plenum assembly | ×1 |

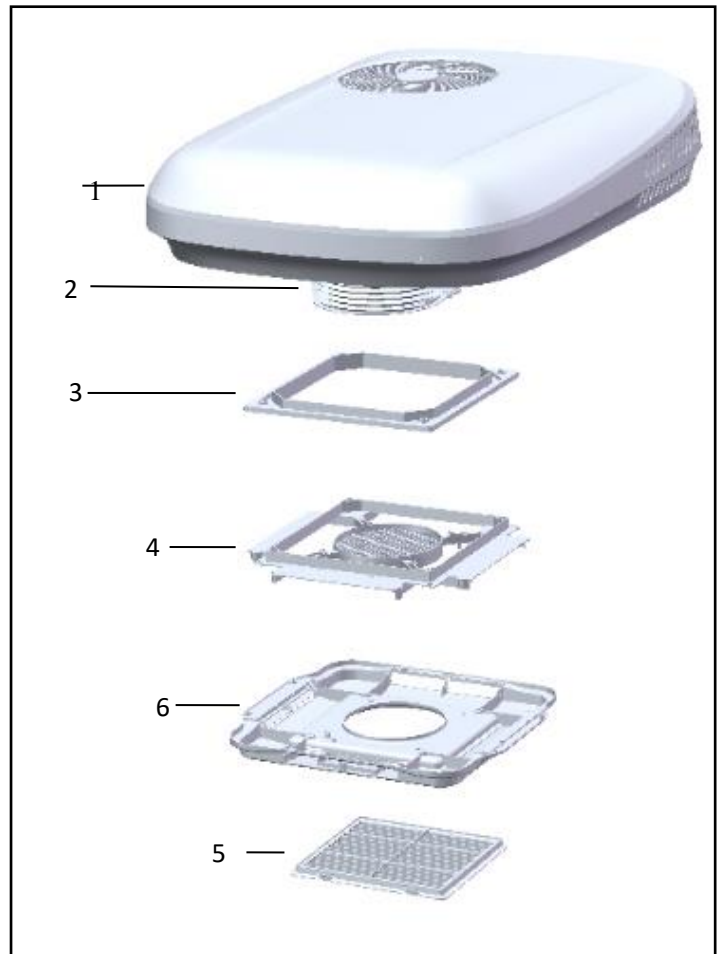

Accessories & fixing devices:

- | | |
|------------------------------------|-----|
| 7. M8 x 120 mm bolts | ×4 |
| 8. Fixing metal plate | ×4 |
| 9. Large washer | ×4 |
| 10. Plenum screw | ×4 |
| 11. Countersunk head tapping screw | ×10 |

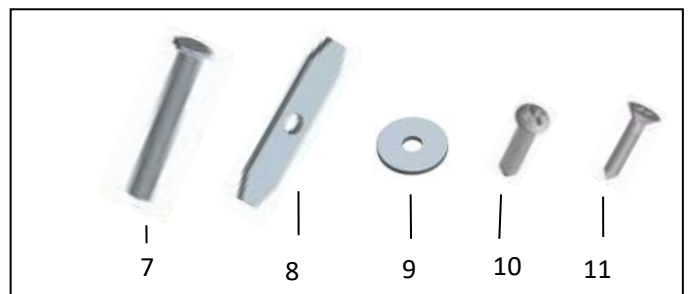

Installation Guidance

Installation instructions

- Read this Manual thoroughly before installation and understand the guidance.
- Abide by the national circuit operation rules in the installation.
- Do not add other parts or restructure the product in the installation.
- The installers shall be equipped with refrigeration technician qualification certificates.
- Consult with HOUGHTON or the local distributor in the case of unusual applications or installation conditions that are not specifically covered by this manual.

Installation requirements

- The RV or caravan roof shall be able to support the air-conditioner's weight (45kg).
- The opening part of the roof shall be able to support the air-conditioner's weight and allow for the corresponding operations.
- Minimum thickness of roof: $\geq 25\text{mm}$; maximum thickness of roof: $\leq 85\text{mm}$.
- If the roof's thickness is beyond the above requirements, you can purchase the enhanced length of the inlet air duct and M8 installation bolts from HOUGHTON or the local distributor.

Load bearing of roof:

- The roof shall be able to bear the weight of the air-conditioner and shall be level without accumulating water. It is suggested that the caravan manufacturer confirms the suitability of the roof for load bearing.
- If the roof is not preserved with holes, they shall be punched from the top of the roof to the inside and use them as leading to punch through the ceiling. It is suggested to consult with the caravan manufacturer to get the best punching method.
- The 360x360mm hole shall be boarded up with wood sections that are at least 20mm thick. This boarding is to ensure that the roof will not crush from the installation bolts and that air-conditioned air does not enter the ceiling space.

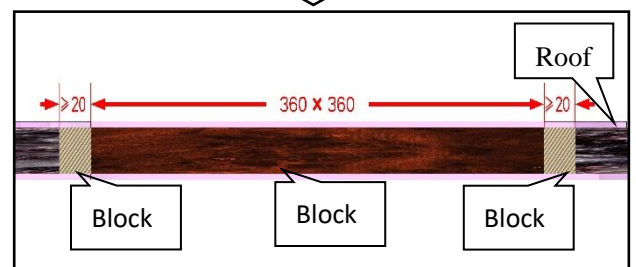
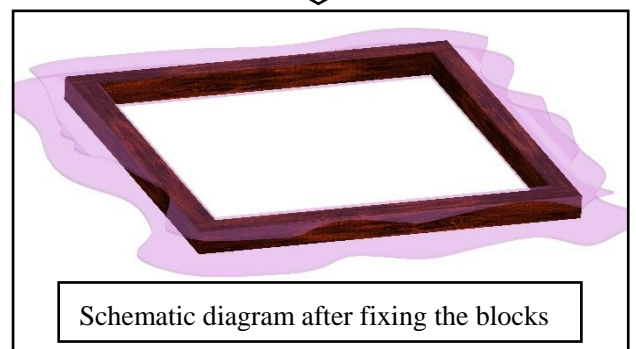
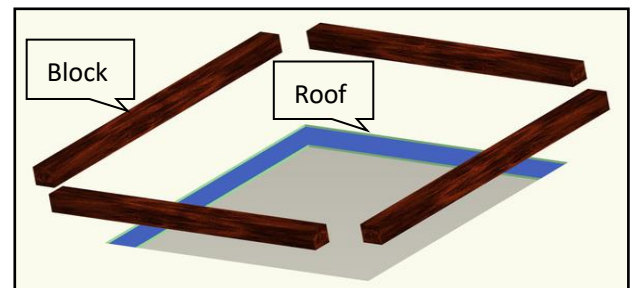

Installation position

Before the installation, consider the installation position:

- The air-conditioner outdoor unit shall be installed at the center of the roof to make sure balance of the air flowing.
- The installation position of the outdoor unit shall be consistent with the traveling direction of the caravan.
- When installing ensure that there is sufficient room for the plenum assembly to be installed.
- The installation positions shall be kept away from the skylights, heaters or light positions that may affect the air flows.
- 360x 360mm cutting position shall be kept away from connecting position at the roof.
- There shall be a space of 100mm minimum all around the roof top unit to ensure suitable air flow and access for maintenance.

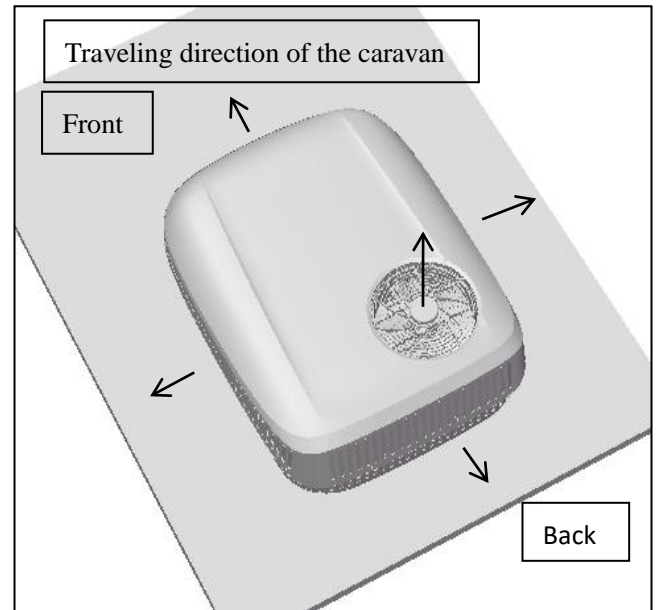

Note

Angle of inclination of the air-conditioner shall not be larger than 5° and the back part of the air-conditioner shall not be higher than the front part.

For advice on installations outside of these limits please contact with HOUGHTON or the local distributor.

- The lower figure shows the minimum clearance distance required between the BELAIRE air-conditioner and any obstructions on the roof.
- The lower figure shows the minimum distance of the installation position of the plenum, measure in reference to 360x 360mm holes.

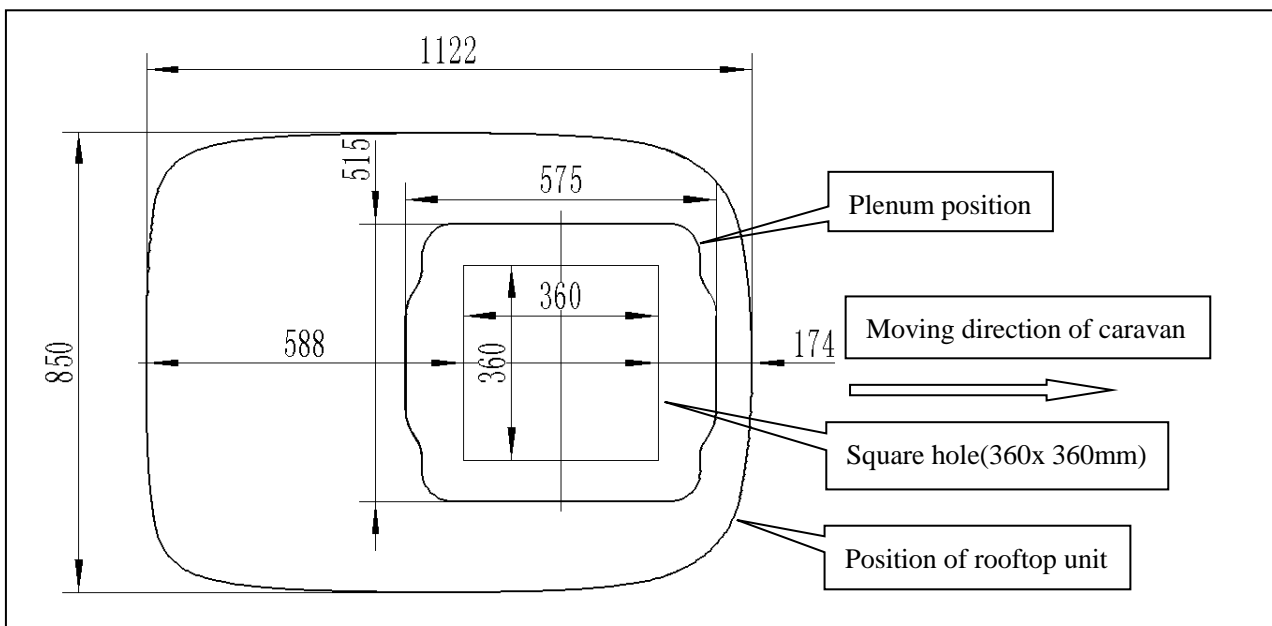

Installation of chassis reinforced

- Make sure the roof is clean and dry and free from oil & grease.
- Confirm orientation by starting with the “this side up” logo upwards.
- Turn the part over and on the reverse side of “this side up”, apply silicone sealant uniformly over the path shown.
- Turn the part over again and make sure “this side up” is up. Press down firmly over the 360×360mm hole and remove any sealant that has squeezed out to form an effective seal.

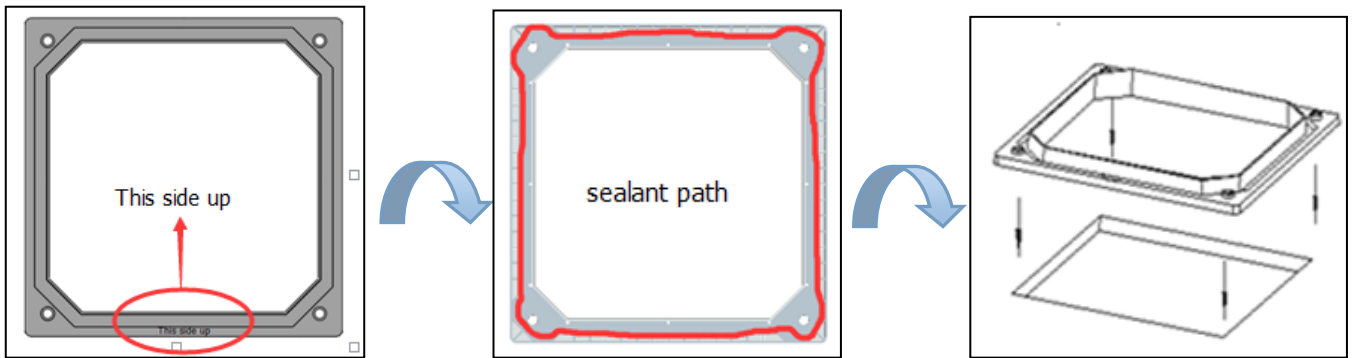

Installation of outdoor unit

- Remove the outdoor unit from the carton and move it to the installation position on the roof.
- Put the outdoor unit over the chassis reinforced support and properly adjust the position to make sure they mate and the four bolt holes on the corners align.

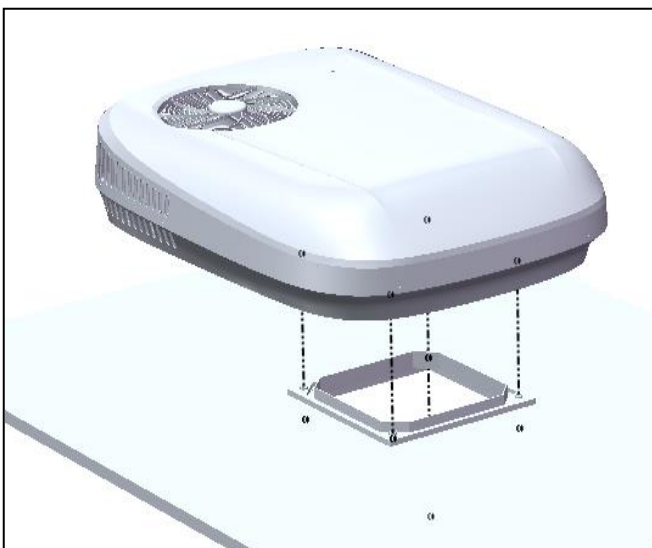

Note

The outdoor unit is about 45Kg, lift the outdoor unit at the same time with another person.

Use the M8 bolts and check if the holes are consistent with the holes of the plenum mounting bracket. If not then use a long screw driver inserted up through the two holes to assist with alignment.

Connect the power supply

- Pay attention to the local wiring regulations that need to be followed when connecting to mains supply.
- Look upward from inside the caravan, and locate the terminal block as shown in the figure below.
- Connect the external power lines to the 3-pole terminal block and note the positions of the active, neutral and ground.

Note

Match the corresponding active (brown), neutral (blue) and the ground wire (yellow green) and firmly tighten up the screws to make sure the power line is not loose or improperly connected, otherwise a short circuit or fire could be caused.

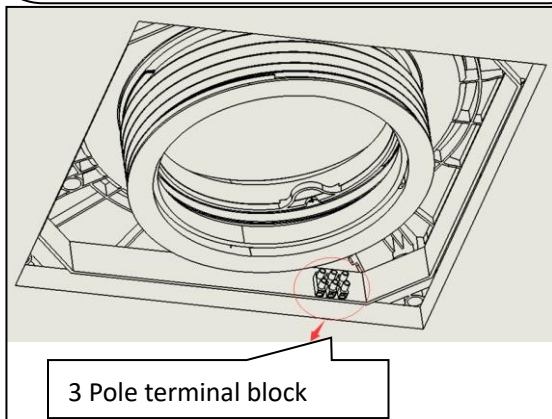

Installation of M8 bolts

- Connect M8 bolts, washers and fixing metal plates in order as the following figure.
- Lift the plenum mounting bracket toward the machine.
- Insert M8 bolts, washers and fixing plates to the holes of the 4 corners. Start the bolts off using finger effort.
- Ensure all bolts have started correctly for at least 2 or 3 rotations to avoid cross threading.
- Ensure the metal fixing plates align with the corresponding recess in the plenum mounting bracket as the bolts are tightened.
- Evenly tighten up all four bolts.

Note

Tighten the bolts to 12-14Nm torque. Do not exceed 14Nm.

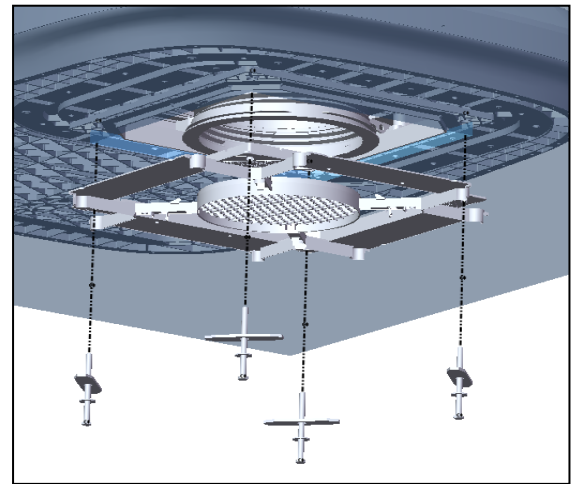

Connection of air inlet duct

- Grasp the the air inlet duct loop II of the flexible air duct end and pull it down.
- pull the air duct loop II down until it touches the plenum mounting bracket, the loop II is connected with the installation racket with four clicks;
- When you hear the clicking sound and the loop II is parallel to the surface of the bracket, it means the ring is matched well with the bracket.

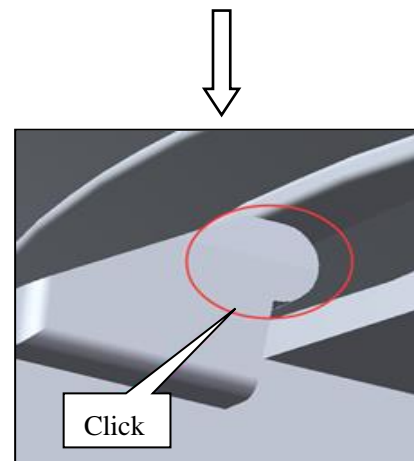
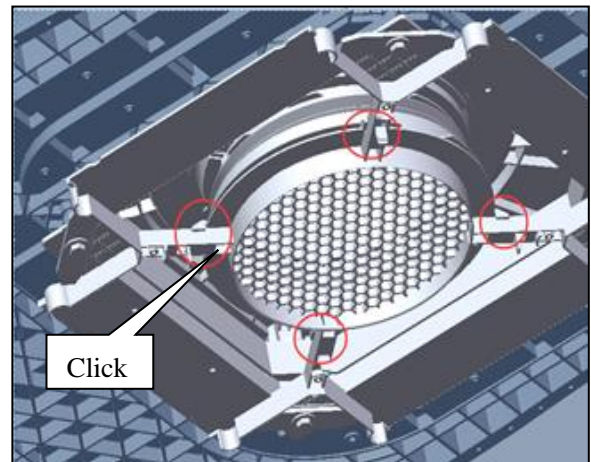

Installation of the plenum assembly

- Remove the air filter from the plenum, the both tabs inwards to push, and then gently shake down;

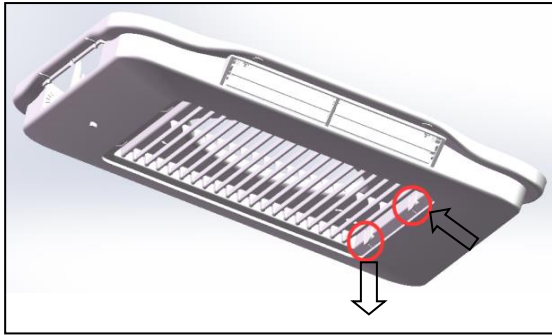

- Connect the socket and plug of the display panel wires and the controller wires, please notice that colors of the wires should be matching (yellow to yellow, red to red, etc).

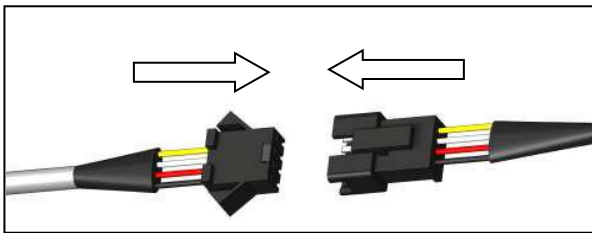

- Attach the plenum assembly to the plenum mounting bracket by engaging the two parts, you will hear four clicks to as the parts connect together.

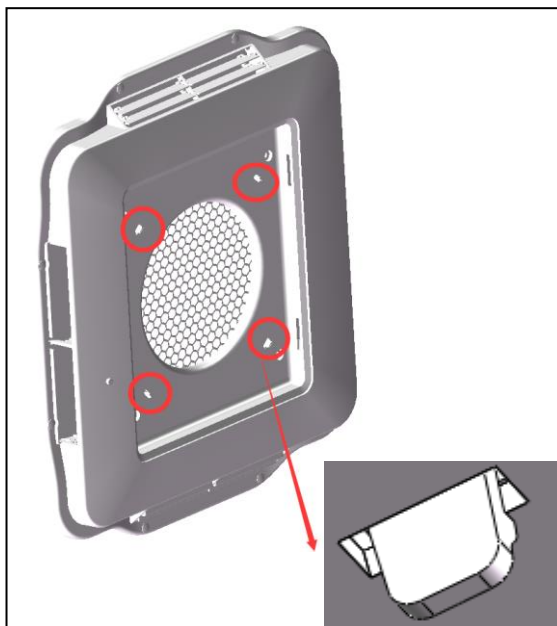

- Fix the plenum assembly on the plenum mounting

bracket with four ST4*19 pan head screws.

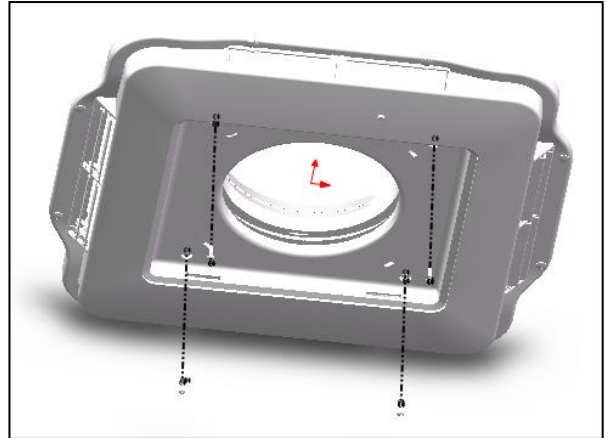

- Remove the screw caps from the plenum;
- Fix the plenum assembly on the plenum mounting bracket with 8 standard equipped countersunk head screws;
- Install return screw caps to the plenum.

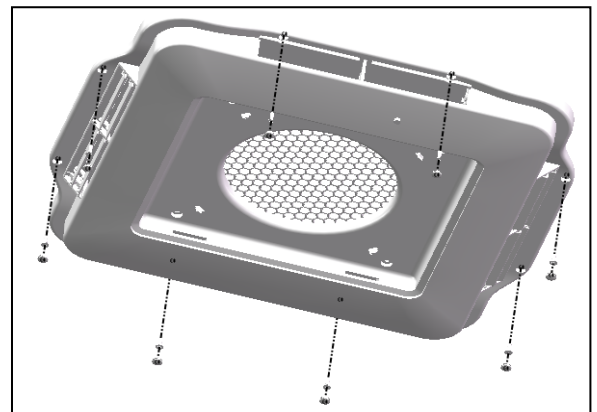

Installation of the air filter

- The side of the air filter to highlight the tabs insert slots in the plenum;
- Push the air filter upwards until both tabs into slots of the plenum;
- When heard two clicking sound.

The installation is all completed.

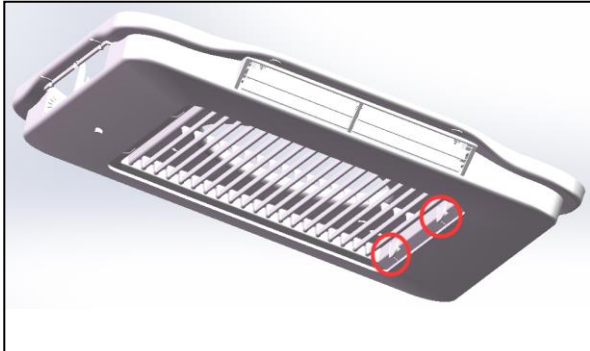
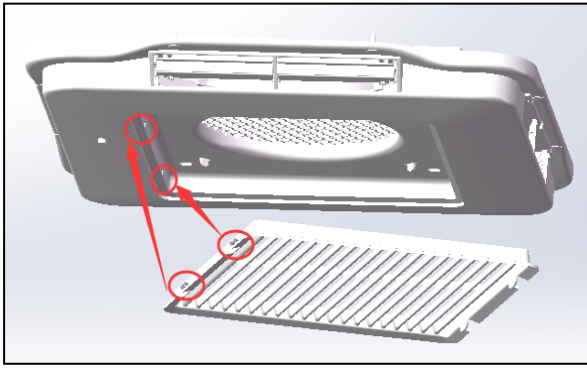

Adjust the louver

- Adjust direction and angle of louver by moving blade around its axis. The 2 blades move together. Louvers on opposite sides are symmetrical.

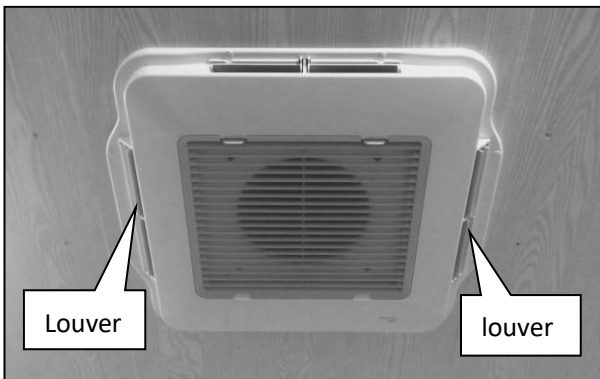
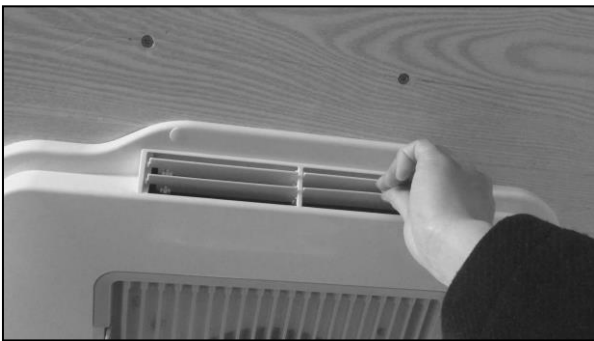

- Adjust direction and angle of louver by moving the raised piece in the center of louver. Louvers on opposite sides are symmetrical.

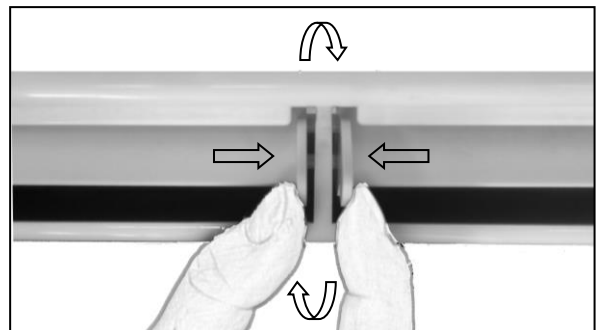
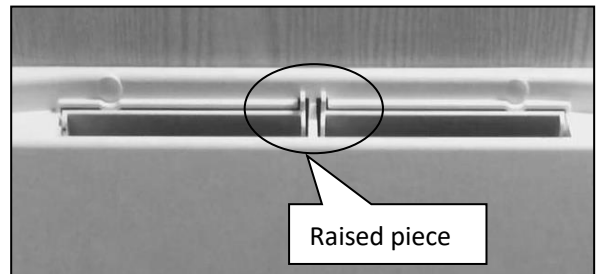
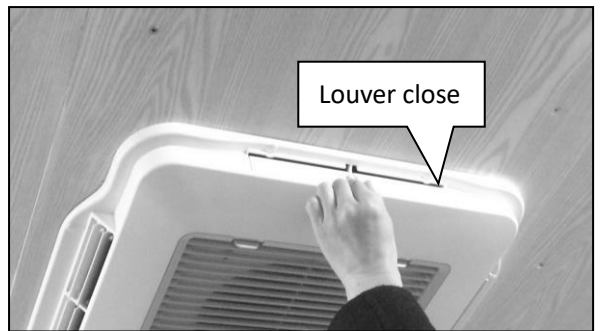
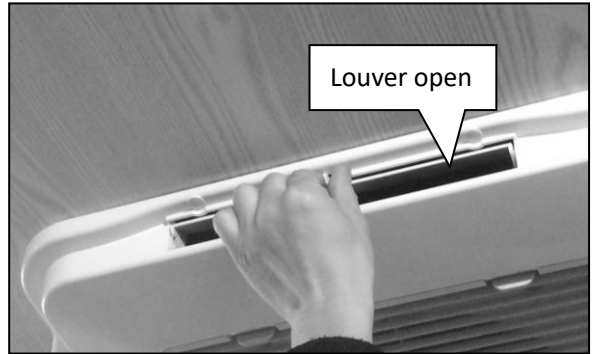

Instructions for Use

- Switch on the power to the air-conditioner at the isolation breaker.
- Start the air-conditioner by switching to FAN mode to select the fan FAN.
- Operate in low FAN, medium FAN and high FAN in turn to check normal operation.
- To select the COOL mode, adjust the set point temperature to three degrees lower than the room temperature, the unit will start to blow cold air after the compressor starts.
- To select the HEAT mode, adjust the setting temperature as three degrees higher than the room temperature, the device will start to blow hot wind soon.

Note

After selecting the COOL/HEAT mode, the compressor will have a delay start for three minutes.

Operation Instruction of the Remote Controller

Remote controller

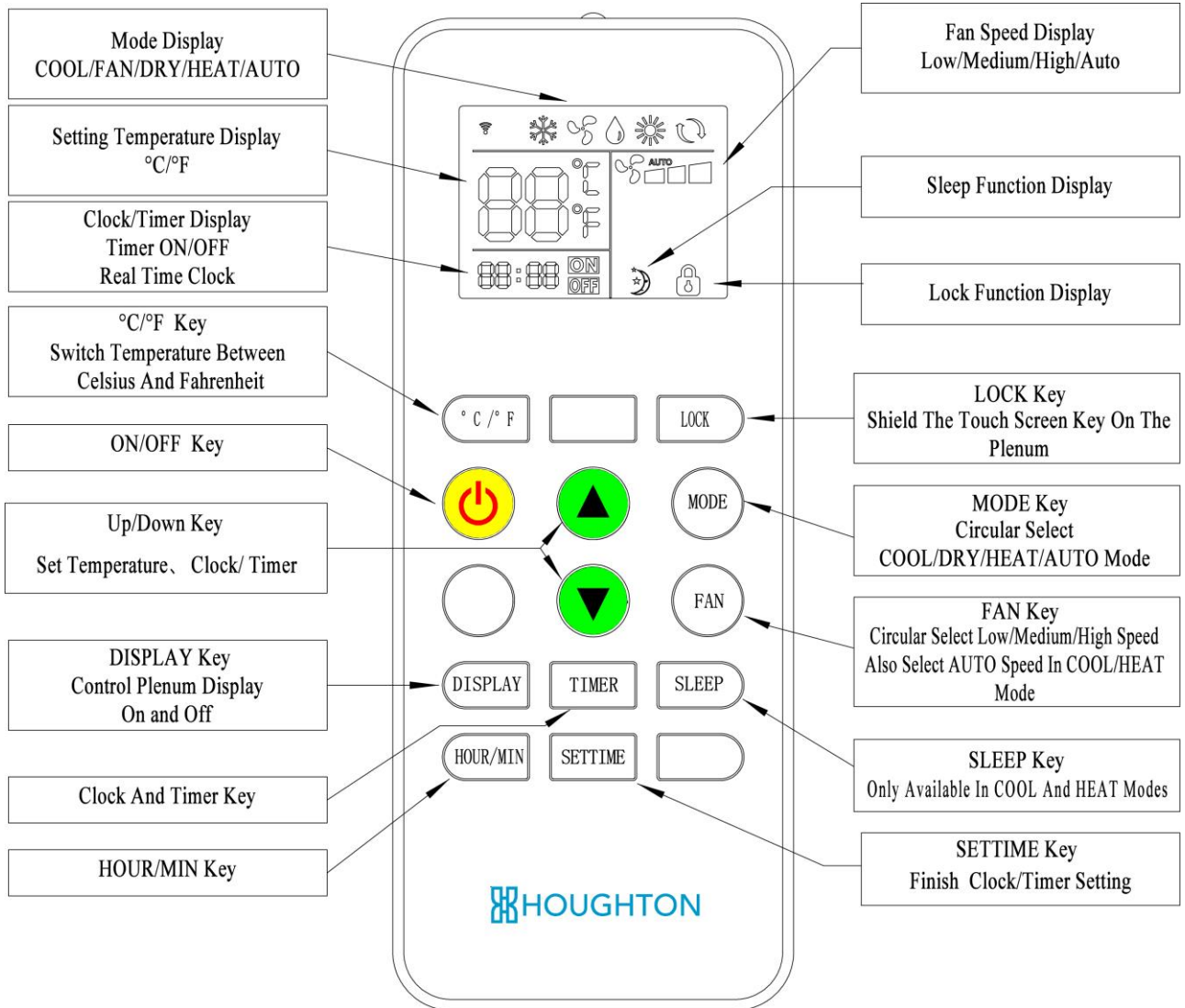

Plenum display

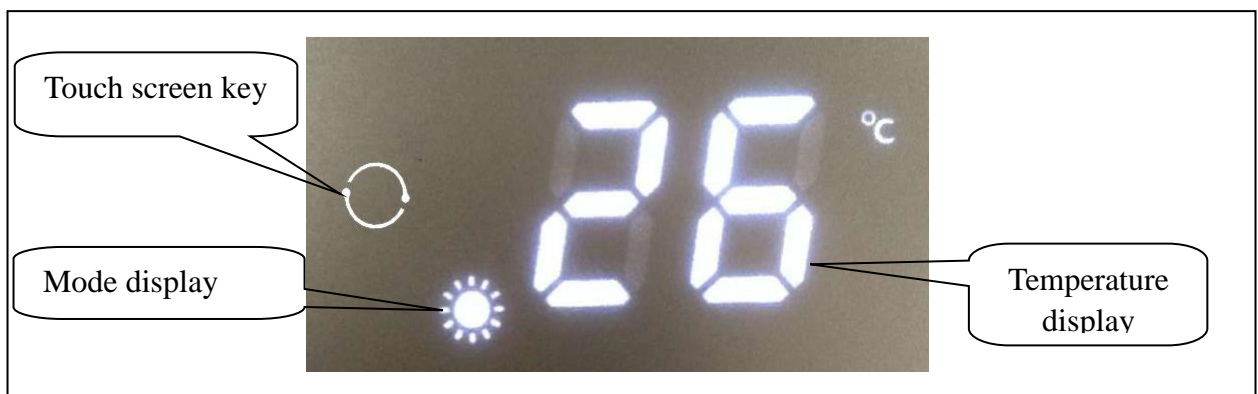



1. Operation of the remote controller

Turn on

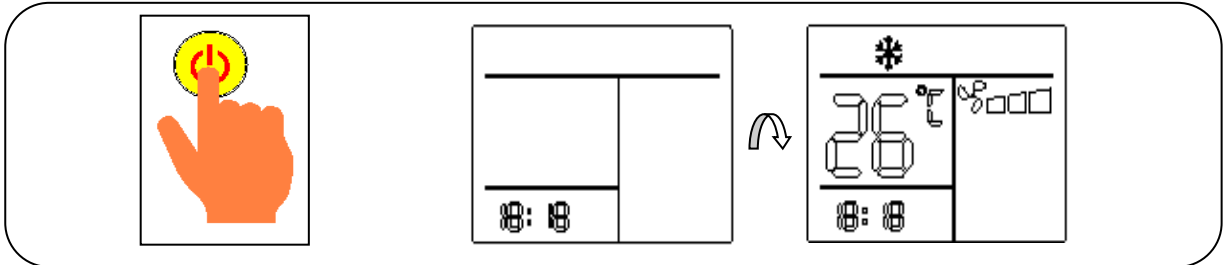
- Press the on/off “” key, the machine turns on, the buzzer of the plenum beeps one time and the running mode and temperature will be displayed.



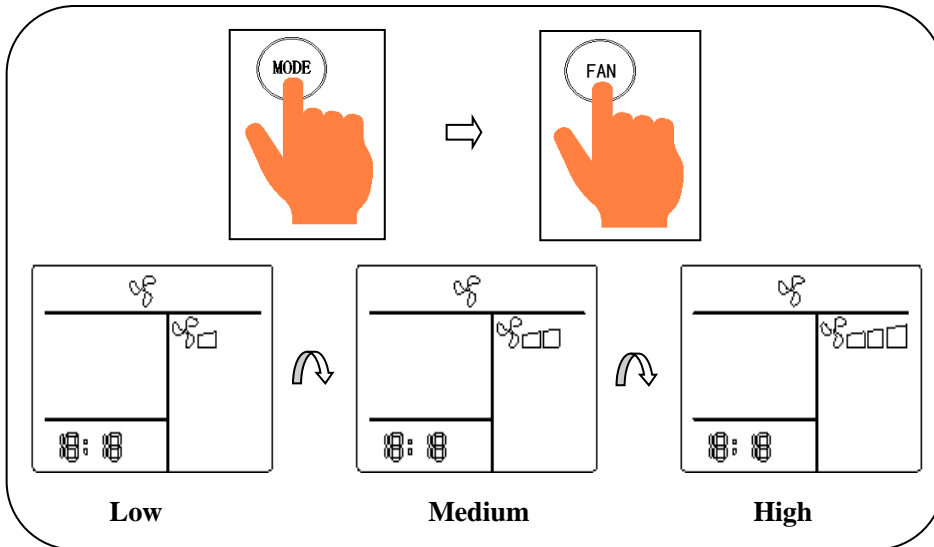

FAN mode

- Press the “MODE” key, select the “” mode, Press the “FAN” key, Select Low/Medium/High FAN circularly and the plenum will display “” and the indoor environment temperature.



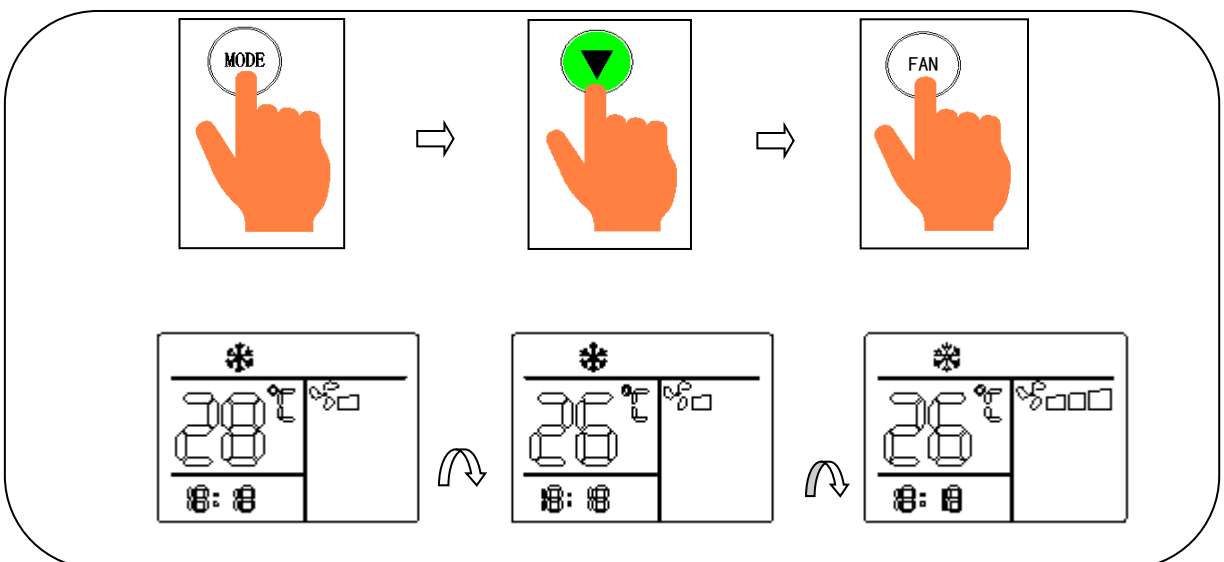

COOL mode

- Press the “MODE” key, select the “” mode, Press the down “” key to set the temperature lower than the room temperature, Press the “FAN” key to select different speed. and the plenum will display “” and the setting temperature.



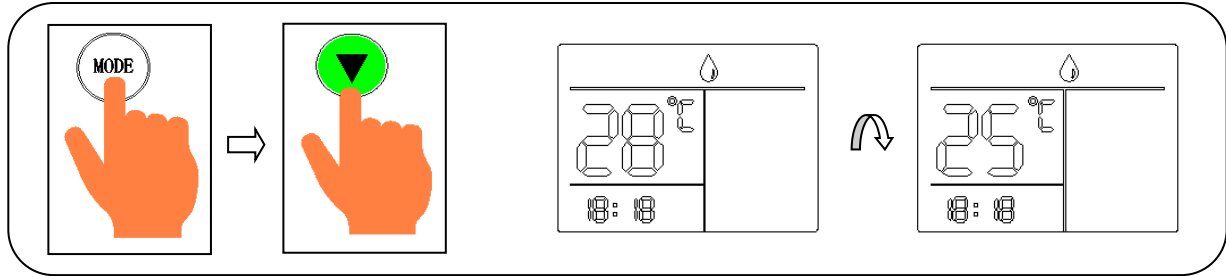

DRY mode

Press the “MODE” key, select the “” mode, Press the down “▼” key to set the temperature 1°C lower than the room temperature , and the plenum will display  and the setting temperature.





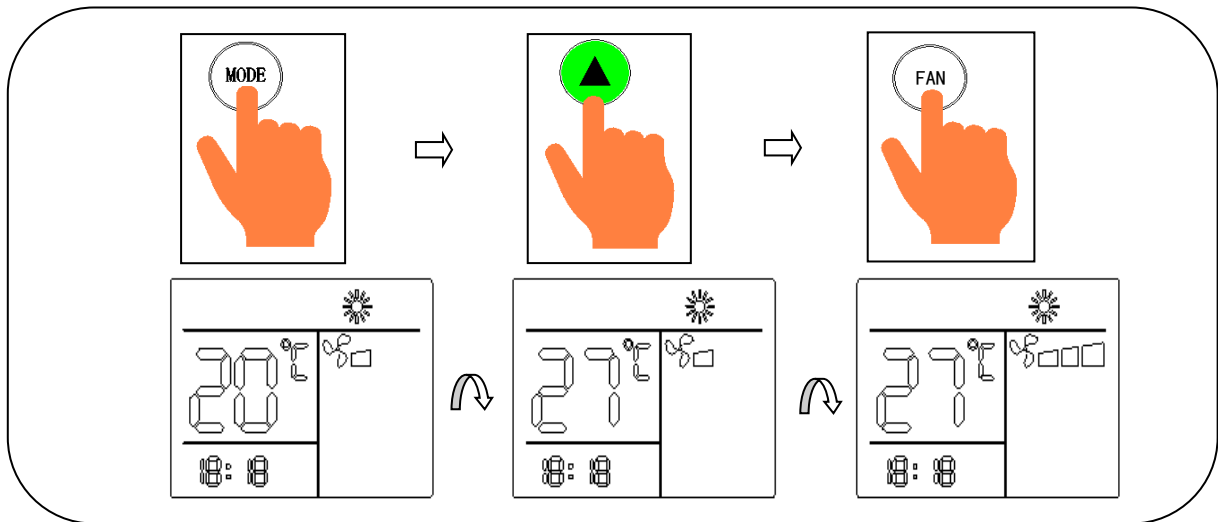

HEAT mode

● Press the “MODE” key, select the “” mode, Press the up “▲” key to set the temperature higher than the room temperature ,Press the “FAN” key to select different speed. and the plenum will display  and the setting temperature.



AUTO mode

● Press the “MODE” key, select the “” mode, Press the up “▲” or down “▼” key to set different temperature ,Press the “FAN” key to select different fan speed. and the plenum will display  and  ,or  and  , and the setting temperature.

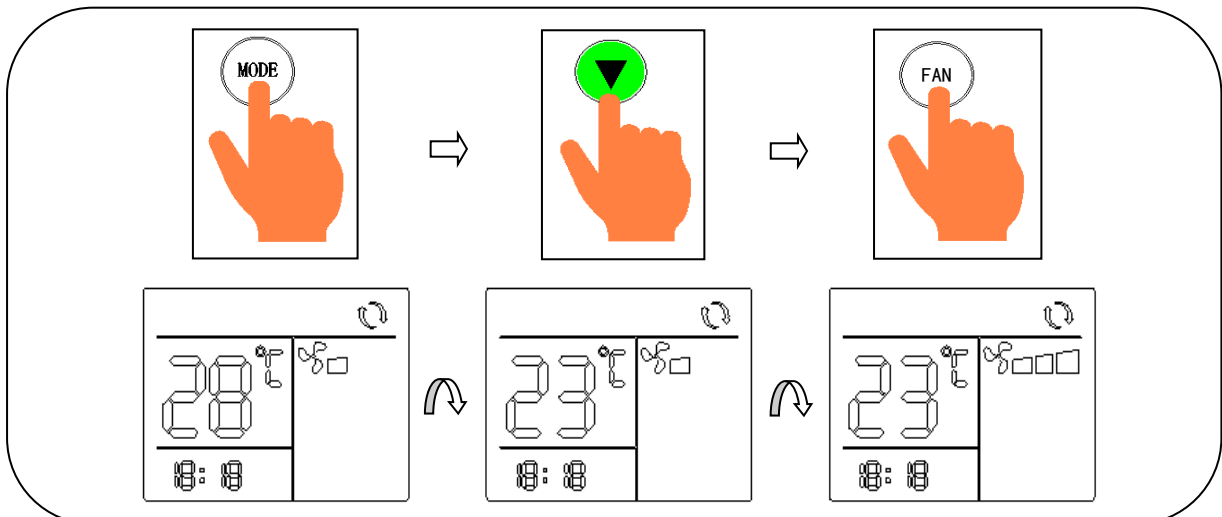

Note

When in the AUTO mode, according to the difference between the setting temperature and the environmental temperature , the plenum will display“☉”and “☀”(automatic heating) , or “☾” and “❄” (automatic cooling) in the same time.

Celsius and Fahrenheit degree change

- In any mode , Press the “°C/°F” key , you can select temperature between Celsius and Fahrenheit.

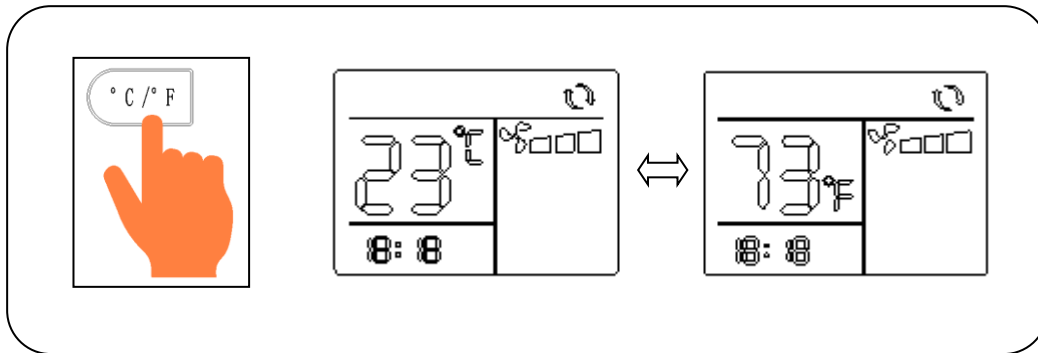

Turn off



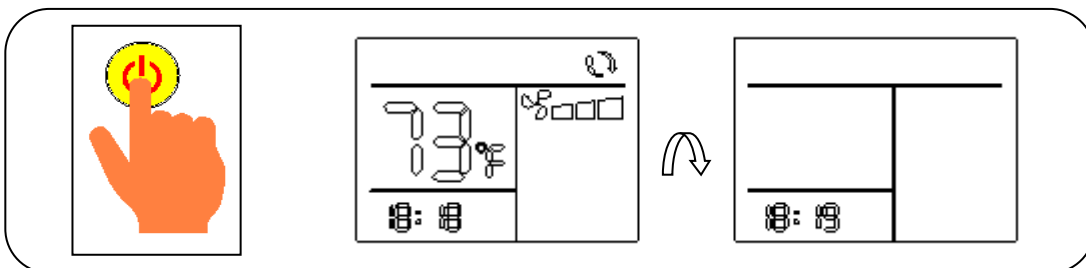

- Press the on/off “” key again , unit turns off and the plenum will display nothing.



2. Plenum operation

- Press the touch screen “” key on the plenum, the setting will be circularly from “ OFF ->COOL ->FAN ->HEAT” modes for every pushing. The setting temperature is 24°C in high fan FAN.



- Mode display of the plenum are as: COOL “”, DRY, FAN “”, HEAT “”, AUTO “” .

Note

In case the plenum touch screen key is locked by the remote controller, operations of the key would be not available. Press the lock key on the remote controller again to unlock!

Tips

- The remote controller should be operated by directing at the plenum, which will beep once when received signal, otherwise operate after adjusting the distance and angle.
- The unit will blow cold air in COOL mode and hot air in HEAT mode.
- When the unit is on, press the “DISPLAY” key on the remote controller, the control plenum LED display will be on and off.
- When the unit is on, press the “LOCK” key on the remote controller to shield and invalidate the touch screen key on the plenum.
- The air-conditioner features power cut memory and automatic starting-up after power back functions.
- Low temperature heating will cause frosting, during when it is normal to show “DF” on the plenum.
- When the environmental temperature is lower than 0°C, the heating effect is reduced, suggest adopting other ways for heating in the same time.
- If the device is left unused for long time, please remove the batteries from the remote controller.

Product Maintenance

Filter

- The return air filters are the only components needs to be maintained periodically.
- Check and clean the filters each week when in use to prevent the filters from being blocked by dirt.
- The filters should be washed frequently to ensure effective cooling and heating.
- Pull out the filter from the plenum before washing in warm water with a touch of detergent.



Replacement filters can be ordered separately.

Screw check

- It is recommended that the bolts holding the unit to the roof are checked for tightness 3 months after the first installation of the product.
- These bolts should be regularly inspected every 12 months through-out the air conditioners life.

Maintenance

- It is recommended that the air-conditioner is operated regularly to ensure good performance.
- In the case of a caravan that will not be used regularly then the unit should be operated for 20-30 minutes every 6 Months.
- In case the caravan is parked outdoors for long time, suggest using protective jacket to protect the outdoor unit of the air conditioner from wind and sun.

Specification Parameters

Model	H3200	H3400	
Power supply	220 ~ 240V/50Hz	220 ~ 240V/50Hz	
Refrigerant charged	R407C/900g	R407C/900g	
Rated cooling capacity (W)	3200	3400	
Rated heating capacity (W)	2800	3000	
Input power for cooling (W)	1300	1350	
Input power for heating (W)	1200	1250	
Rated current for cooling (A)	5.6	5.8	
Rated current for heating (A)	5.2	5.4	
Maximum input power(W)	1650	1700	
Maximum current (A)	7.2	7.4	
Maximum design pressure (kPa)	2900	2900	
Minimum design pressure (kPa)	1840	1840	
Maximum air flow (l/s)	150	150	
Installed weight (kg)	45+3	45+3	
Outdoor unit dimension	Height 223mm	Width 850mm	Length 1122mm
Plenum unit dimension	Height 49mm	Width 515mm	Length 575mm

- Notes:** 1. All parameters listed are subject to change without notice and the nameplates on the machine shall prevail;
 2. E&OE All values are approximate & subject to change.

Exploded Diagram and Parts List

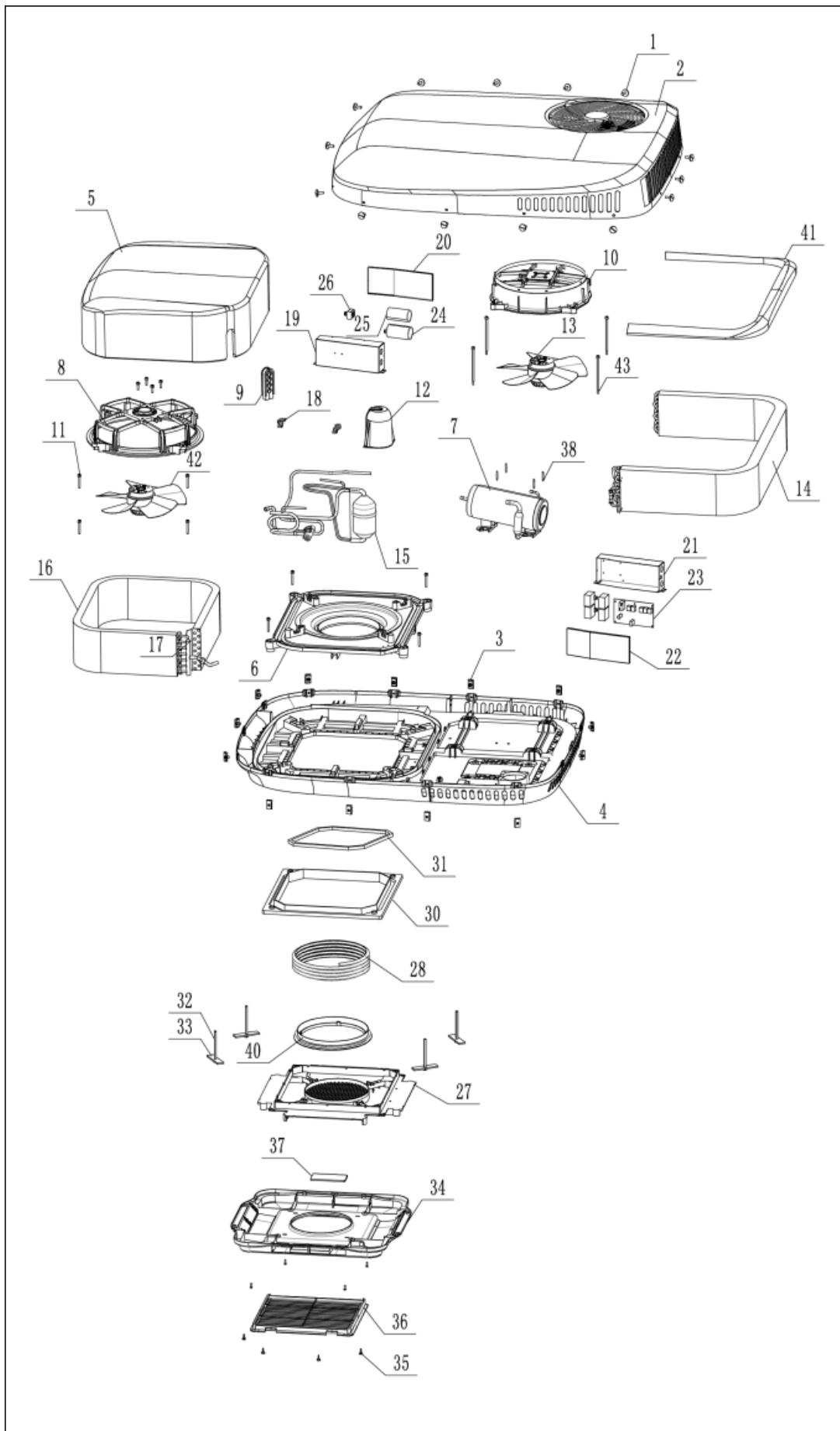

No.	Figure No.	Name	Qty
1	18-12-13	Slotted large raised cheese head screw (white paint sprayed)	13
2	4708-1000-01	Canopy (silk-screen pattern)	1
3	4638-1000-10	B type plate spring nut	13
4	4708-1000-02	Base(with inserts)	1
5	4708-1000-08	Evaporator housing	1
6	4708-1000-07	Evaporator fan deck	1
7	4678-1000-06	Compressor	1
8	4708-1000-09	Internal motor bracket	1
9	4708-1000-15	Pipe clamp	1
10	4708-1000-24	External motor bracket	1
11	18-12-18	Inside fan screw	4
12	4708-1000-14	Accumulator holder	1
13	4708-1700-26	Outer rotor fan	1
14	4708-1210-00	Condenser components	1
15	4708-1030-00	Four-way valve components	1
16	4608-1220-00	Evaporator components	1
17	4678-1230-04(d)	Evaporator retaining plate	1
18	4708-1230-06	Pipe fixed plate	2
19	4708-1701-05	Electrical box 1	1
20	4708-1701-06	Electrical box lid	1
21	4708-1701-07	Electrical box 2	1
22	4708-1701-06	Electrical box lid(with same 20)	1
23	4708-1240-00	Electronic control components	1
24	TDQ-04204	Compressor run capacitor	1
25	4678-1701-02	Compressor start capacitor	1
26	4678-1701-03	PTC	1
27	4709-0000-02	Air duct brace	1
28	4679-0000-04	Air duct	1
29			
30	4709-1000-07	Reinforced support	1
	4709-1000-07(E)	Reinforced support(Collocation is 400 * 400 square hole)	1
31	4678-1000-17	Seal pad	1
32	18-10-59	M8 bolt(M8*120)	4
33	4709-1100-01	Fixing metal plate	4
34	4709-1000-01	Plenum assembly	1
35	3159-1010-08	Screw cap	8
36	4709-1000-04	Air filter	1
37	4708-1241-01(d)	Display board	1
38	3068-1000-13(ZH1)	Compressor screw	4
39			
40	4709-0000-12	Air duct loop 2	1
41	4708-1210-11	Condenser thermal insulation layer	1
42	4708-1700-27	Inter rotor fan	1
43	4708-1000-23	Outside fan screw	4

Trouble shooting guide

No display of the plenum when press the On/Off

- Check whether the access to the power of the RV OK ?
- Check whether the remote battery is OK ?
- Check whether the remote control is off .
- Poor connecting of the control line between the outdoor unit and the plenum, maybe fallen off .

Cooling not available

- To make sure the mode is chosen as Cooling, and the light of cooling mode “ ❄ ” is on.
- The temperature setting value on the remote controller should be lower than the indoor temperature.
- The compressor has a delay start for three minutes.

Heating not available

- To make sure the mode is chosen as Heating, and the light of heating mode “ 🔥 ” is on.
- The temperature setting value on the remote controller should be higher than the indoor temperature; the compressor has a delay start for three minutes.
- More time would be needed for starting heating under extremely cold condition.

Poor cooling capacity

- To make sure the filter is clean.
- Turn on the fan to high FAN to obtain the maximum capacity.
- To make sure all the doors and windows, as well as the sunroof are closed.
- Curtains and awnings can be used to decrease the heating load.

Communication fault	E0
Room temperature sensor fault	E1
Indoor coil temperature sensor fault	E2
Outdoor coil temperature sensor fault	E3
Inadequate coolants	E4
Temperature anomaly	E5

E1: Room temperature sensor

Fault in connection to temperature sensor or other damage.

E2: Indoor coil temperature sensor

Fault in connection to temperature sensor or other damage.

E3: Outdoor coil temperature sensor

Fault in connection to temperature sensor or other damage.

E4: Insufficient refrigerant-capillary tube fracture leads to coolants leakage, compressor fault or sensor failure.

E5: Temperature anomaly-outdoor coil temperature too high when cooling or too low when heating (When cooling, the display of E5 indicates the outdoor temperature exceeds 68°C. It is likely due to the reduction of air low of the condenser, poor working of condenser fan or sensor failure; when heating, if the outdoor temperature is higher than 18°C, the external air blower may be on and off circularly. The occurrence of this is not a fault, but the self-protection of the system for avoiding overheating of the unit.)

Fault codes displayed on the panel

- In case there is “0” or any messy code when the generator supplies power, this may indicate unstable voltage and current.

Answer the following questions as far as possible when contacting for fault diagnosis:

- If any error code is displayed?
- Whether the display panel is in normal operation or not? Whether the temperature displays from 16 to 30°C?
- Whether the temperature can be freely adjusted from 16 to 30°C When in cool or heat mode?
- Whether there is “0” shown in the display?
- Whether any messy code on the display?
- Whether the switching of low, medium and high FAN wind is available after FAN setting? Whether any air out?
- Whether the compressor is working or not?

Circuit Diagram

