



CRUISETM MASTER

BCS

BODY CONTROL SYSTEM



User Manual

Get the latest version at www.cruisemaster.com.au/downloads

Revision	Revision Detail	Date
1	Draft	28/10/2024
2	Production Release	16/12/2024
3	General Update	18/02/2025

The Cruisemaster Body Control System

The Cruisemaster Body Control System (BCS) is a fully electronic control system for the Cruisemaster Air suspension system fitted to your trailer or caravan. The Cruisemaster BCS allows automatic setting of ride height when setting off, and levelling of the trailer when setting up on uneven ground.

The Cruisemaster BCS has Bluetooth™ capability, allowing you to use the Cruisemaster BCS App to remotely control the system and access new features and usability improvements as the product evolves.

The Cruisemaster BCS consists of the *Body Control Module (BCM)* which is the user interface, *Air Control Modules (ACM)* which control air flow, *Air Compressor*, *Air Tank* and *Air Tank Drain Solenoid*. The BCS can be optioned with the *Advanced Inflation* kit which allows automatic tyre inflation and deflation, and an *Odometer* kit to keep track of travel distances and maintenance.

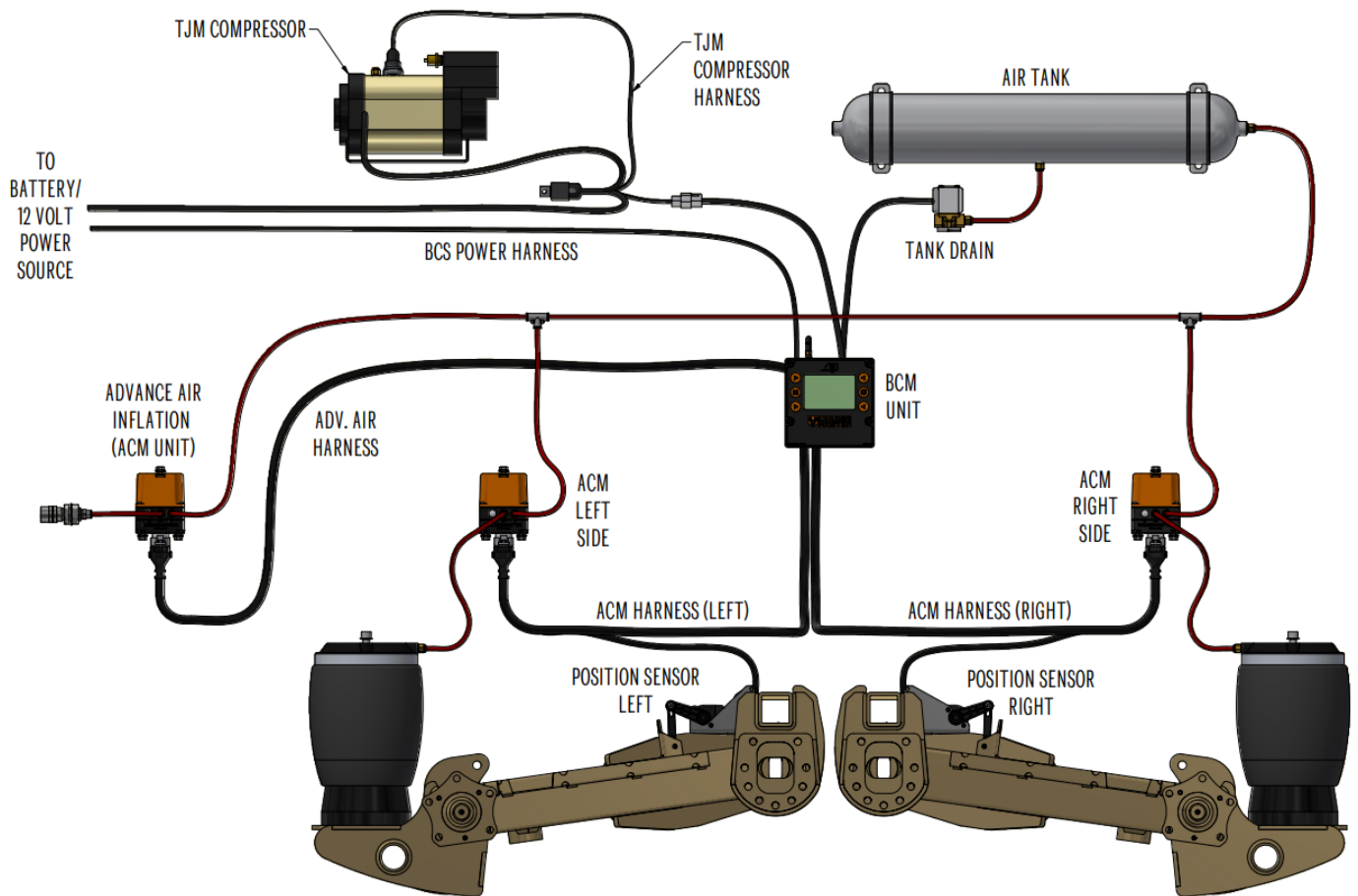

Warnings And Safety Instructions

SAVE THIS GUIDE: Before commencing installation or use of the Cruisemaster Body Control System (BCS), please ensure you have read, understood and saved this Installation and User Guide. Also ensure that all the components listed in this guide are supplied.

DISCLAIMER: Cruisemaster accepts no liability for injury, loss or property damage which may occur due to improper or unsafe installation and/or use of the Cruisemaster Body Control System.

WARNING

1. Compressed air can be dangerous. This system must only be operated by a competent person, in compliance with the operating procedures and recognizing the risks outlined in this document.
2. Always operate the system in a safe manner.
3. Keep all persons and pets clear of the trailer during operation.
4. Always be aware of the surroundings of yourself and the trailer prior to operation.
5. Ensure all persons and pets are clear before releasing air from the tank drain valve.
6. Do not use any function of the system on or toward people, children or pets.
7. Do not use any function with the trailer stabiliser legs down. Only use the stabiliser legs after the function is complete.
8. Air venting from the system (via Quick Connect port, ACM exhaust or Air Tank Drain solenoid exhaust) may be loud.
9. Ensure you have read and fully understood the instructions in the **Inflator Menu** section prior to using the inflation function.
10. Ensure installation or repair of the system or any of its components is carried out by a competent person.
11. Ensure the system is de-energised prior to commencing installation or repair of the system and/or its components.
12. ALWAYS use jack stands and ensure the trailer is safely secured and wheels chocked prior to installation, repair and operation. DO NOT work under insecure loads.
13. Do not remove, modify or bypass the pressure relief valve. Pressure relief valve may only be replaced by an equivalent rated (155psi) valve.
14. All Air Control Modules (ACM) MUST be vented to external atmosphere.
15. Use the supplied airline cutter for cutting all airline in the system.

CAUTION

1. Ensure a fuse is installed at the power supply source for the Body Control System (BCS) (5A) and air compressor (refer to the manufacturers user manual for fuse size).
2. Ensure all electrical connections are insulated.
3. Ensure all harnesses/cables are secured at regular intervals and are protected from sharp edges to prevent chafing and wear.
4. DO NOT use thread tape on any fittings or components as it may result in component failure. Cruisemaster recommends the correct use of thread sealant. Wear the correct PPE and follow the manufacturers specifications and procedures for correct application.
5. Periodically check the safety relief valve (usually installed on compressor) by ensuring air is released when the manual override is pulled.
6. Periodically check all airlines and fittings for leaks.
7. Periodically check all fasteners and mounting hardware are securely installed.
8. Follow the manufacturer's instructions for the installation and use of the air compressor. ALWAYS use the appropriate fuse for the application and ensure the compressor is properly mounted to reduce vibration and noise.
9. Exercise caution when performing water crossings to not submerge the air compressor (if it is mounted externally or beneath the trailer)
10. Do not replace the Bluetooth antenna with an alternate part.

PERSONAL SAFETY MEASURES: Please follow the preceding measures to ensure the safe installation and use of the BCS.



1. Use the appropriate PPE for the task being completed while using the BCS.
2. Use eye protection whenever there is a risk of dust being blown into the vicinity of the user and bystanders. Dirt particles can irritate the eyes, skin and respiratory system.
3. Use heat-proof gloves when working with hot equipment. The air compressor may get very hot during use.
4. Parts of the system may create loud noise and vibration. Use hearing protection if exposed to loud noise.



Contents

The Cruisemaster Body Control System	2
Warnings And Safety Instructions	3
Contents.....	4
Body Control Module	5
Accessory Air Port.....	14
Air Control Modules	14
Position Sensor & Linkage.....	15
Manual Inflation Points	15
Air Supply System	16
System Specifications	17
Cleaning	17
Maintenance.....	17
Servicing.....	18
Troubleshooting.....	18
Diagnostic Values Guide	19
Electrical Schematics	20
Air System Schematic	22

Body Control Module

The Body Control Module (BCM) allows you to view the status of the system and operate the various functions and modes. The key components are the 3.4" LCD display, 6 button keypad and Bluetooth antenna. The Menu  and Confirm  key functions are fixed, the remaining key functions are linked to the text or icon shown on the display beside the key.

Power Modes

The BCM operates continuously once connected to the power supply, this allows the background functions such as the Odometer to function correctly. When power is first connected, the BCM will start automatically, then show the home screen.

- After 3 minutes of inactivity at the home screen, the BCM will go into sleep mode to reduce power consumption, and the screen will appear blank. The BCM can be woken from sleep mode by pressing any key.
- After 3 minutes of inactivity in the menu, the BCM will return to the home screen.
- The BCM can be restarted by pressing and holding the Menu key, this should only be required if the BCM is not operating correctly.
- To fully isolate and disable the BCM, remove the fuse at the power source.

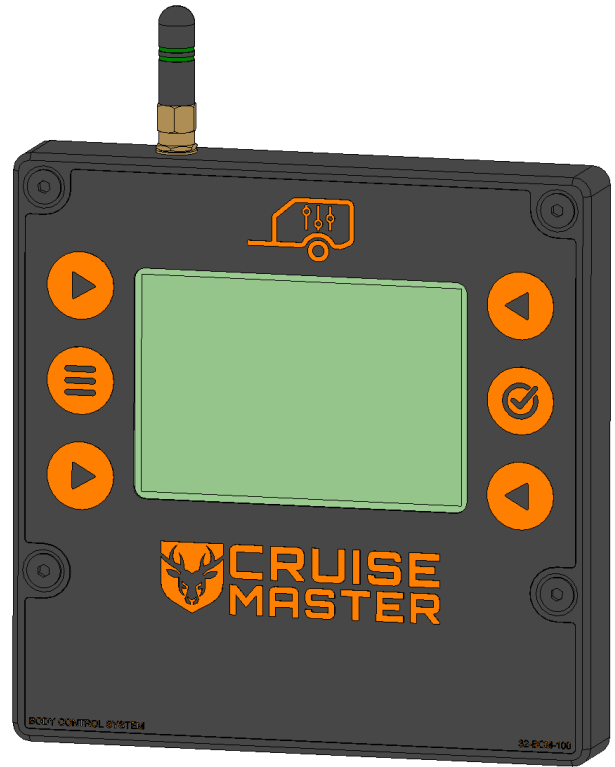

Home Screen

The Home screen shows the user the BCS status and allows the BCS suspension control functions to be activated.

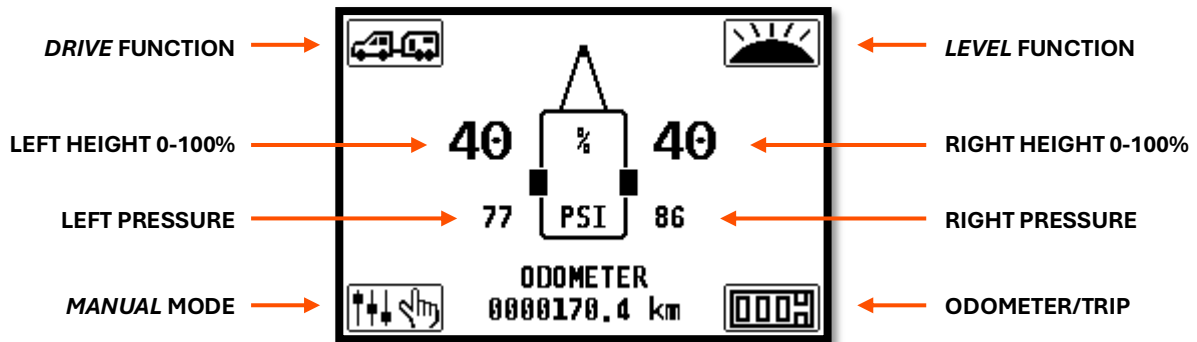

Suspension Status

Central to the screen are the left and right suspension status values.

The upper values show the current height of the suspension, with minimum height showing 0% and maximum height showing 100%. The lower values show the airbag pressure, which will vary from left to right depending on the total weight and weight distribution of the trailer. The critical value for suspension control is suspension height, airbag pressure is displayed for user reference.

Warning



Before activating any of the BCS suspension control functions:

- The trailer should be safely secured (attached to the tow vehicle or parking brake applied with wheel chocks)
- Ensure the area above, below and around the trailer is clear of objects, people and pets.
- Do not use any function with the trailer stabiliser legs down. Only use the stabiliser legs after the function is complete.

Note



Activating BCS suspension control functions will enable the air compressor, the compressor will continue to run for up to 3 minutes after the function is complete to refill the air tank. The compressor is then disabled to prevent nuisance activation.

DRIVE Function

The upper left key on the home screen activates the DRIVE function, which automatically sets the suspension height for best towing performance.

The DRIVE function is best activated on level ground before setting off. The trailer should be stationary, with nothing touching or moving the trailer.



LEVEL Function

The upper right key on the home screen activates LEVEL function, which automatically sets the trailer most level relative to the horizon.

Use the LEVEL function when setting up camp or accessing the trailer when parked on uneven ground. The system will prioritise levelling the trailer in the Roll axis (left to right), then in the Pitch axis (front to back).

When the LEVEL function is activated, the system will advise the user to perform manual adjustment (jockey wheel adjustment or levelling blocks) to achieve perfect level.

The user can make the recommended adjustments or simply press the [checkmark icon] key to proceed. The trailer should be stationary, with nothing touching or moving the trailer.



MANUAL Mode

The lower left key on the home screen activates MANUAL mode. This mode allows the user to control the suspension position.

The air flow is directly controlled by the user pressing the up [up arrow icon] and down [down arrow icon] arrow keys on the left and right. This mode is useful for many scenarios:

- Raise trailer to easily stow corner steadies
- Raise trailer to access a spare tyre or drain valve
- Lower trailer to park under a low ceiling
- Lower trailer to reach external fixtures
- Angle the trailer to avoid obstacles on tight trails
- Drain all air from the airbags for servicing the system

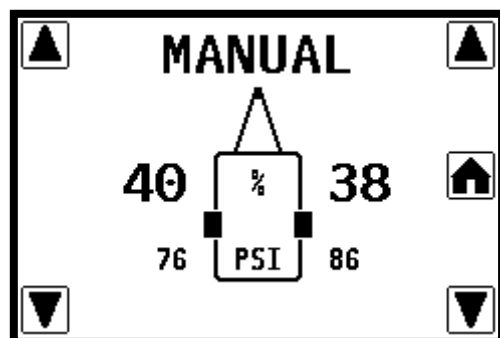

To exit MANUAL mode, press the [checkmark icon] key.



ODOMETER/TRIP (If enabled)

The lower right key on the home screen cycles between the odometer distance value and the trip distance value when pressed. Press and hold when viewing the trip distance value to reset.

Main Menu

Press the  key to enter the Main Menu and cycle through the menu screens. Press the  key to select a menu item.

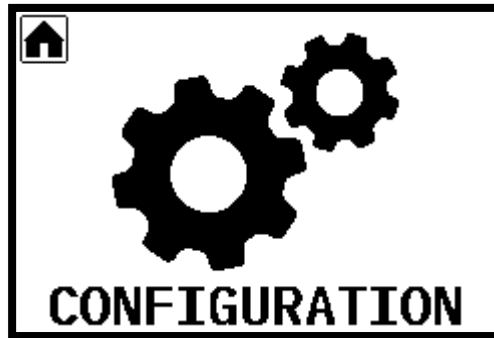
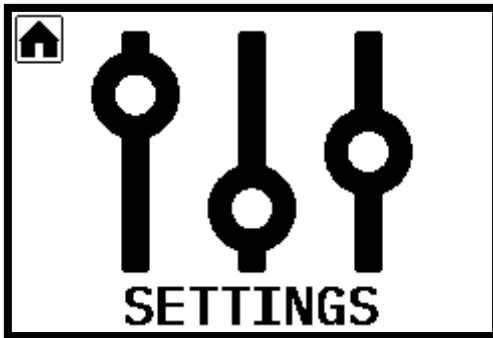
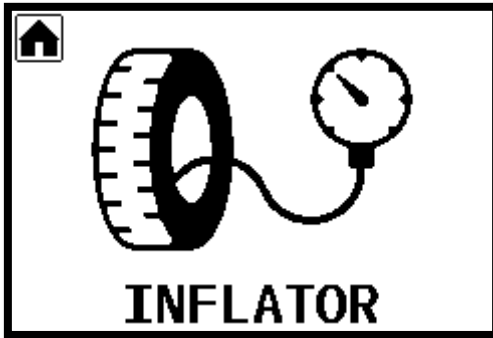

Inflator Menu

If the *Advanced Inflation* system is installed and selected upon configuration, the Inflator menu will be shown.

The *Advanced Inflation* system uses an Air Control Module to control the flow of air to and from the Air Accessories Port, which allows for automatic inflation and deflation of tyres and airbags. The *Advanced Inflation* system is to be used with an ‘open’ style quick release or clip-on air chuck as shown below, rather than the inflation wand.

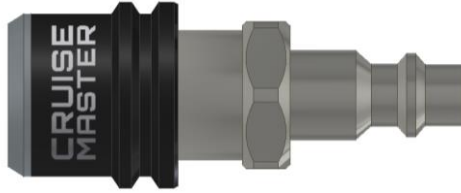

Warning



- **Ensure you have read and fully understood the instructions prior to using the inflation function.**
- **Use the inflation function for automotive tyres and suspension airbags ONLY. Do not use on bicycle tyres, balls etc.**
- **Ensure appropriate eye and hearing PPE is worn prior to using the inflation function.**
- **Ensure inflation pressure does not exceed the tyre manufacturers specifications.**
- **Never direct compressed air toward people, children or pets.**
- **Always inspect tyres, hoses and connections for damage or looseness before commencing inflation.**
- **Always monitor the inflation system during operation.**
- **Wheels/tyres to be inflated should be suitably secured, e.g. attached to the vehicle or spare tyre holder.**

Note



- Do not inflate more than 8 tyres per hour with TJM Pro-Series Single Compressor.
- Activating the Inflator function will enable the Air Compressor, the Compressor will continue to run for up to 3 minutes after the function is complete to refill the Air Tank. The Air Compressor is then disabled to prevent nuisance activation.
- All pressures shown by the unit are relative to the barometric pressure, which allows accurate inflation pressure at any altitude.

Automatic

Automatic mode is recommended when inflating or deflating tyres or airbags.

To use Automatic mode, the tyre or airbag must have a pressure of at least 5psi/35kPa.

- Attach the quick connect chuck to the tyre valve.
- Adjust the set pressure using the up ▲ and down ▼ arrow keys.
- Press and hold the ⏻ key to start.
- The *Advanced Inflation* system will inflate or deflate the tyre to achieve the set pressure.

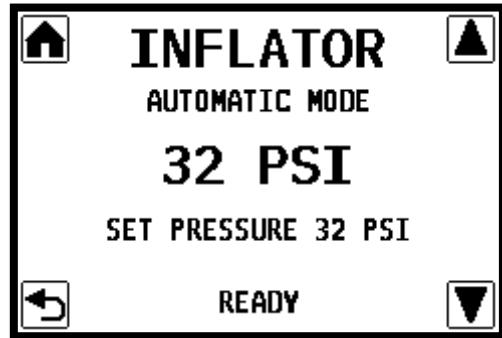

Manual

Manual mode is recommended when complete or fine control of the inflation system is desired.

In Manual mode the air flow is directly controlled by the user pressing the up ▲ and down ▼ arrow keys.

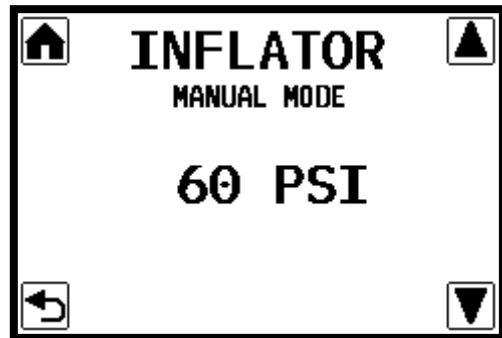

Tools Menu

This menu contains auxiliary functions the user can perform with the system.



Air Accessory Mode

Enables the air compressor for 30 minutes, or until another air control function is activated. It allows the user to manually activate the compressor to supply air when external air accessories are connected to the system.

Bluetooth

To connect to the BCS with a mobile device, download the Cruisemaster BCS mobile app from the Apple App Store or Google Play Store. Follow the prompts in the mobile app to connect to the BCS.



Air Tank Drain

Press and hold  to activate the tank drain solenoid. Tank drain can be used to drain the tank fully to allow for servicing the system.

Warning



Ensure all persons and pets are clear before releasing air from the tank drain valve. Air venting from the tank drain solenoid may be loud.

Note



Tank drain function disables the air compressor if it is currently enabled.

Diagnostics

This screen provides an overview of the critical values used by the system to allow troubleshooting. Refer **Diagnostic Values Guide**.

Settings Menu

The Settings menu allows you to adjust the user interface to your preference.

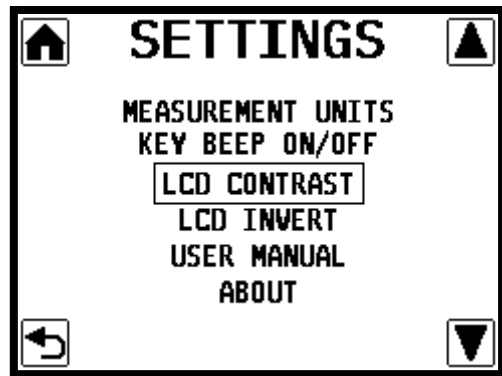

Units

Select between metric and imperial units.

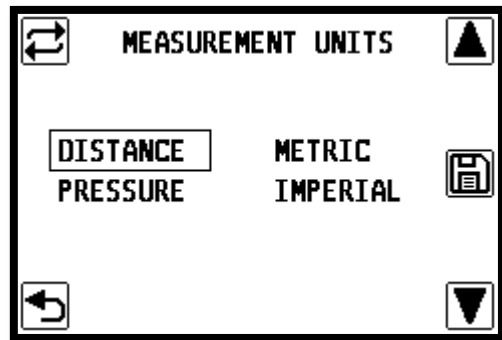

Key Beep On/off

Turn the beep on key presses on or off.

LCD Contrast

Adjust the contrast of the LCD display for the best viewing performance. This should be adjusted to give the best image at the normal viewing angle.

LCD Invert

The LCD image can be inverted if preferred by the user, similar to “dark mode” interface.

User Manual

QR code link to this Manual location on the Cruisemaster website.

About

Bluetooth, Hardware and Software Information relevant to the Body Control Module.

Configuration Menu

This menu contains the configuration values and functions.

These functions are only required to be performed or altered on initial installation of the system, or if the mechanical configuration of the system changes (such as wheel alignment, BCM relocation, linkages or sensors removed and reinstalled).

On initial installation, progress through each function in the order listed.

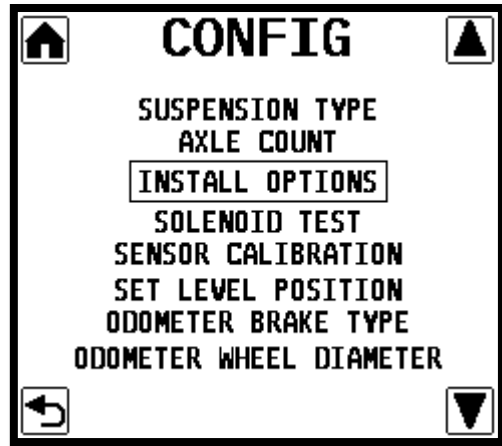

Install Orientation

Set the orientation of the BCM relative to the trailer, this allows the BCM to correctly sense roll and pitch angles.

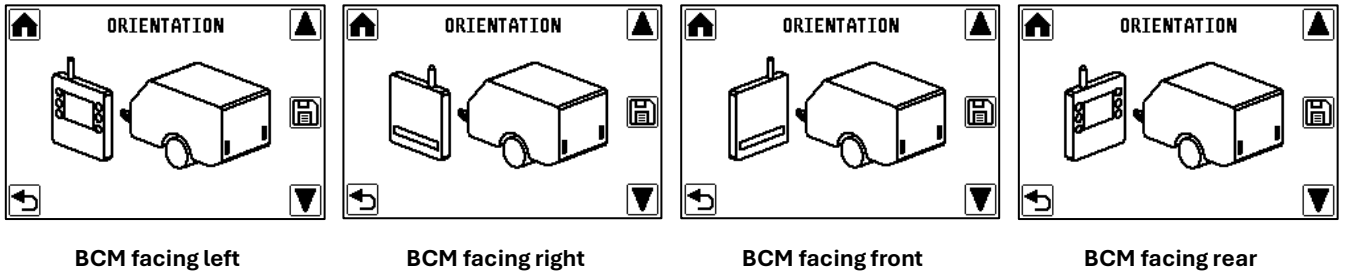

Note

For correct operation of the LEVEL function, the BCM should be mounted vertically, aligned with the trailers principle axes (longitudinal, lateral, vertical).

Suspension Type

Select the suspension fitted to the trailer. To identify the suspension fitted to the trailer, check the product badging on the suspension arm when viewed from the rear. Alternately, ATX suspension uses a Rolling Sleeve type airbag, XT suspension uses a Convoluted type airbag.



ATX Rolling Sleeve Airbag

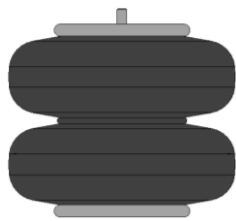

XT Convoluted Airbag

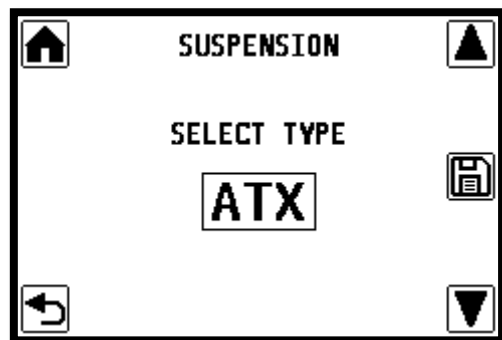

Install Options

Wheel Speed Sensor

Select if a Wheel Speed Sensor is connected to the system, this activates the Odometer/Tripmeter and other speed sensitive functions.

Inflator

Select if *Advanced Inflation* is fitted to the system. This activates the Inflator function.

Solenoid Test

This function briefly activates each of the outputs of the system and records the electrical current draw in Amps for future reference & error checking. Press and hold the  key to start the test.

SOLENOID TEST	
LEFT AIR IN	: 1.048
LEFT AIR OUT	: 1.050
RIGHT AIR IN	: 1.020
RIGHT AIR OUT	: 1.015
INFL AIR IN	: 0.021
INFL AIR OUT	: 0.021
TANK DRAIN	: 0.410
AIR COMP	: 0.021

Sensor Calibration

This function learns the suspension control and position sensor limits. **Before performing this function, the following conditions are critical:**

- BCM to be sturdily mounted to the trailer
- BCM to be aligned with the trailers principle axes (longitudinal, lateral, vertical)
- Trailer on flat and level ground
- Supported by the jockey wheel/jack.
- Wheel alignment performed
- Tyre pressure correct
- Nothing touching or moving the trailer
- Ample space around the trailer for suspension to raise, lower and roll.
- Air tank to be full. (This can be done by activating **Air Accessory Mode** function until the air compressor shuts off by the pressure switch)

This function cycles the suspension in the following sequence:

- Suspension at highest height.
- Suspension at lowest height.
- Suspension rolled to the left.
- Suspension rolled to the right.
- Suspension set to nominal ride height position.

Once this function is complete, the **Set Level Position** function below may need to be performed.

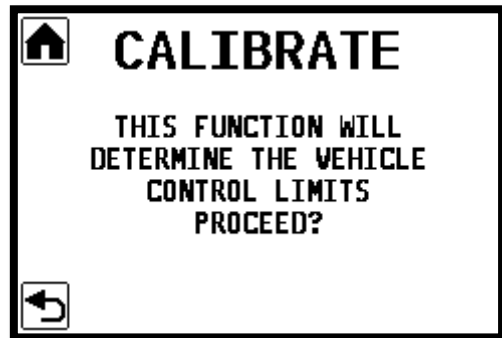

Set Level Position

This function sets the true level position of the trailer, to compensate for any mounting angle of the BCM and manufacturing tolerances of trailer and suspension. The saved position (angles relative to the horizon) will be used as the target angles for the LEVEL mode.

The user adjusts the suspension until the surface of interest (floor, bench top, etc) is level with the ground in the roll and pitch axis directions.

This is best done by using a spirit level on a flat surface while adjusting the suspension in MANUAL mode. It is recommended to set the roll axis level with MANUAL mode, then adjust the pitch axis to level with the jockey wheel.

Once the trailer is level, enter "Set Level Position" function and press  to save the position.

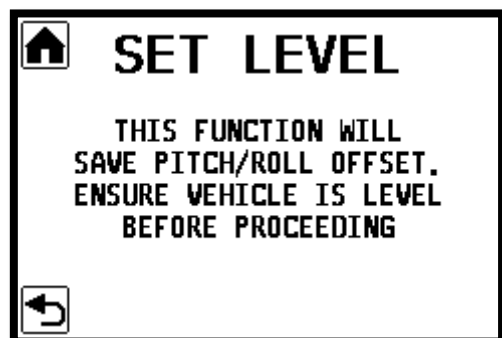

Brake Type (if Wheel Speed Sensor fitted)

Set the type of brake system installed for correct calculation of wheel speed and odometer distance. Each brake type has a specific number of tone wheel teeth to be detected by the wheel speed sensor as the wheel turns.

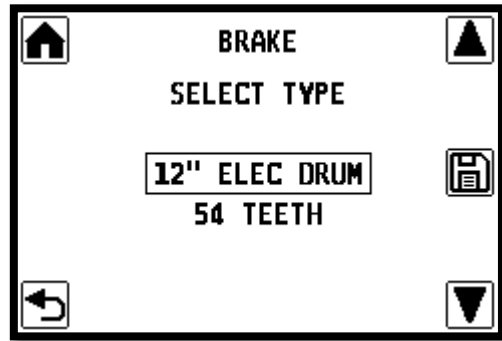

Wheel Diameter (if Wheel Speed Sensor fitted)

Set the tyre size for accurate calculation of wheel speed and odometer distance.

- Set the Section Width, Aspect Ratio and Wheel Diameter as per the fitted tyre.
- For commercial tyre sizing e.g; 195R15C, where aspect ratio is not given, select the blank. E.g. 195/ R15
- For other tyre sizing, adjust the Section Width, Aspect Ratio and Wheel Diameter combination until the tyre diameter most closely matches the diameter of the fitted tyre.

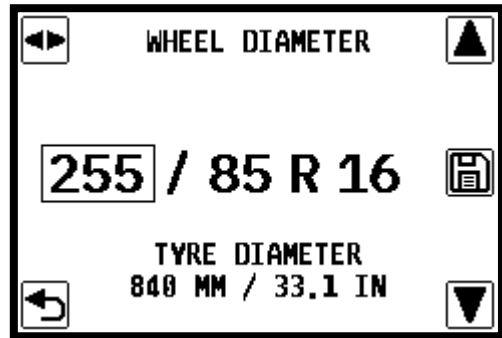

Accessory Air Port

The Accessory Air Port allows the use of air powered accessories.

With *Advanced Inflation* installed:

- The port air flow and pressure is controlled by the BCS
- To inflate/deflate tyres, refer to the **Inflator Menu** section above.
- To use conventional air powered accessories such as the supplied Inflation Wand, Air Accessory Mode must be enabled, this provides constant pressure to the Accessory Air Port and enables the Air Compressor.

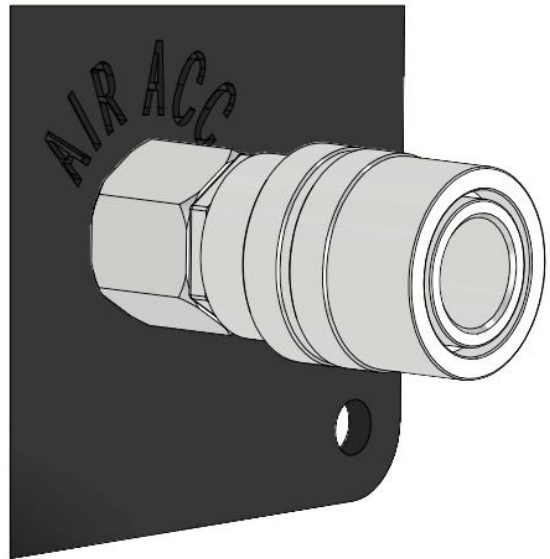

Warning



Never use the Quick Connect Chuck with Air Tool Mode. This will provide uncontrolled air to the tyre, causing overinflation or rupture of the tyre.

Without *Advanced Inflation*:

- This port is directly connected to the Air Tank
- Conventional air powered accessories can be connected to the port.
- The Air Compressor must be enabled to allow it to maintain the supply pressure. Under the Tools Menu, activate the **Air Accessory Mode** function.

Air Control Modules

The Air Control Modules (ACM) control the flow of air to and from the airbag on each side of the trailer (or tyre, when used with the Advanced Inflation kit). The key components of each ACM are 2 solenoid valves, a check valve and a pressure sensor. To raise the trailer, the fill solenoid is opened, allowing pressurised air to flow from the air tank (**IN** port) to the airbag (**OUT** port). This causes the airbag to inflate, pushing the trailer upward. To lower the trailer, the drain solenoid is opened, allowing air to flow from the airbag to the atmosphere (**EX** port).

A silencer is fitted to the **EX** port of the ACM, to reduce the sound level produced by air being released to the atmosphere. Over time, the silencer may become blocked with dirt and mud, reducing the system performance when lowering the trailer or deflating tyres. Should this occur, the silencer should be replaced, refer to the Error! Reference source not found. section.

A vent is fitted to the housing of the ACM, to prevent pressure build up and ingress of water. This vent should be kept clean and clear of debris to ensure long life of the ACM. Refer to the **Cleaning** section.

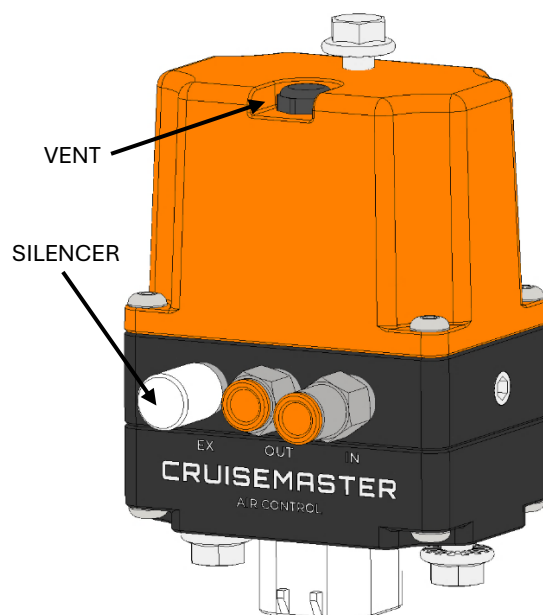

Position Sensor & Linkage

The Position Sensor and Linkage measures the position of the control arm of the suspension. The BCS uses the position signal to control the height of the suspension when using the DRIVE and LEVEL automatic functions.

The Position Sensor is an automotive grade sensor with a non-contact measurement design to ensure high accuracy and long life.

The linkage is constructed from 316 grade Stainless Steel and high strength plastic, to prevent corrosion and excessive friction.

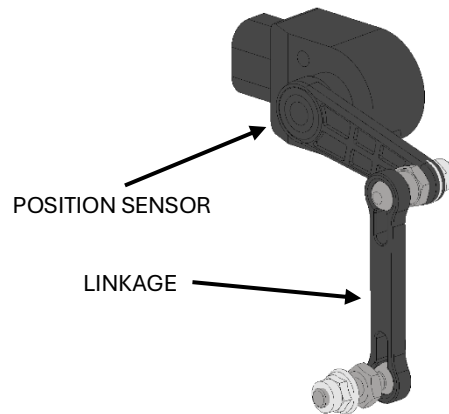

Manual Inflation Points

Manual Inflation Points are provided to allow the airbags to be inflated or deflated if the system becomes inoperable. They consist of a standard Schrader valve and valve cap, which can be inflated with a normal tyre pump. They are connected to the air lines between the ACM and the airbags, and typically situated under the trailer near the wheels, but location may vary depending on the manufacturer.

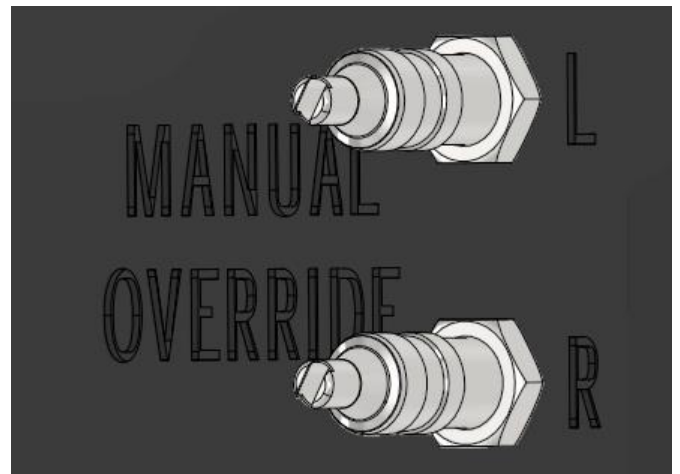

Air Supply System

The Air Supply System pressurises and stores atmospheric air at an appropriate pressure, ready for use by the system. The key components are the Air Compressor, Pressure Switch, Pressure Relief Valve, Air Tank and Tank Drain Solenoid Valve.

Air Compressor

The Air Compressor pumps atmospheric air into the air tank, increasing its pressure sufficiently to inflate airbags and tyres. A filter is fitted to the inlet of the Air Compressor which should be kept clean and replaced if the system is slow to build tank pressure. Where the Air Compressor is mounted externally or beneath the trailer, caution should be exercised when performing water crossings to not submerge the Air Compressor.

Pressure Switch

The Pressure Switch monitors the pressure in the air tank, activating the compressor when the pressure is below 110psi, and deactivating the compressor when above 130psi. The Pressure Switch works in tandem with the BCS control signal to activate the Air Compressor relay as required.

Pressure Relief Valve

The Pressure Relief Valve is activated in case of pressure switch failure, preventing the system from reaching a dangerous pressure level by venting the excess air. The valve should be manually exercised periodically to ensure it moves freely, refer to the Maintenance section for further information.

Air Tank

The Air Tank stores the air produced by the compressor for later use by the system.

Tank Drain Solenoid Valve

The Tank Drain Solenoid Valve is an electrically operated valve which drains air & water from the lowest point of the tank. When compressing atmospheric air, it is common for the humidity in the air to condense inside the air tank, over time this can accumulate and cause issues. The valve can be operated by the **Air Tank Drain** function in the **Tools Menu**, to release the water from the air tank, or to completely drain the air tank for service.

System Specifications

Operating Temperature	-20°C to 60°C
Operating Voltage	12V Nominal, 10V Minimum, 15V Maximum.
Idle Current	~50mA
Operating Current	0.15-2.50A
Maximum Current on Compressor Output	2A (positive switched)
Maximum Current on Tank Drain Output	2A (positive switched)
Operating Pressure	110-130psi (set by Pressure Switch). Do not exceed 130psi.
Overpressure Relief Pressure	155psi (set by Pressure Relief Valve). Do not exceed 155psi.
BCM Dimensions	130x130x18.5 (excludes Bluetooth antenna)
BCM LCD	3.4" Backlit Sunlight Readable
Tubing	¼" Nylon

Cleaning

BCM

Wipe with a damp cloth. Do not expose to water.

Other Components

Gentle hose with fresh water, do not pressure wash or steam clean. Underbody pressure washing systems may be used, however caution should be exercised to avoid pointing high pressure streams directly at the ACM's or other air components.

Maintenance

To ensure the ongoing performance and safety of the BCS, please ensure the following tasks are performed:

Weekly

- Activate the Air Tank Drain function for a few seconds to purge any water that has accumulated in the air tank. Refer **Air Tank Drain** section for detail.

3 Monthly

- Activate the Air Tank Drain function for a few seconds to purge any water that has accumulated in the air tank. Refer **Air Tank Drain** section for detail.
- Test the Pressure Relief Valve (typically installed on the Air Compressor):
 - Activate the Air Tank Drain function for a few seconds to purge any water that has accumulated in the air tank, this also disables the Air Compressor to prevent it starting during the test.
 - Briefly pull the manual override ring and ensure air is released.

Warning



Before testing the Pressure Relief Valve, ensure you are wearing appropriate heat-proof gloves, hearing and eye protection, and all persons and pets are clear. The Air Compressor and Pressure Relief Valve may be very hot, and air venting from the valve may be loud and kick up dust.

- Check the housing vents of all ACM units are clean/not obstructed with mud/dirt.
- Check the exhaust silencer of all ACM units are clean/not obstructed with mud/dirt.
 - Replace silencer if dirt does not wash away, or system performance is poor or slow when lowering trailer or deflating tyres.
- Check the Air Compressor inlet filter is clean/not obstructed with mud/dirt, refer to the compressor manufacturer's requirements.
- Check all airlines and fittings for leaks.
- Check all fasteners and mounting hardware are secure.
- Check all electrical cables and connectors are secure.

Servicing

Wheel Alignment

Due to the movement of the control arm and position sensors during wheel alignment operations, it is recommended to perform Sensor Calibration for best performance. Refer **Configuration Menu > Sensor Calibration** section above.

Component Removal

Removing Electrical Components

To isolate and disable the BCS prior to servicing electrical components:

- Remove the 5A fuse at the power source for the BCS
- Remove the fuse at the power source for the Compressor

Removing Air Components

To remove all air pressure from the BCS prior to servicing:

- Select MANUAL Mode
- Lower each side of the trailer until air can no longer be heard venting from the ACM and the pressure value shown for both sides is zero.
- Activate the Tank Drain function until air can no longer be heard venting from the ACM. Activate the Tank Drain for a further 10 seconds.
- Remove the 5A fuse at the power source for the BCS
- Remove the fuse at the power source for the Air Compressor

Troubleshooting

Airbag pressure is different from left to right

Pressure will vary from left to right depending on the slope of the ground, weight distribution of the trailer and suspension position. Even on level ground with the suspension in a level position, there can be a large difference in air pressure, this is typically due to uneven weight distribution of the trailer or its contents.

BCM display is blank

- BCM may be in sleep mode, press any key to power on.
- Check the state of charge of the source battery.
- Check fuse at the power source
- Check fuse on the back of the BCM
- Check 12V is present at the BCM power connector.

Suspension does not move when DRIVE or LEVEL mode is activated

- If the Air Compressor can be heard running, wait a few minutes for air to build up and try again. The Air Tank may have been depleted by Air Tank Drain operation or an air leak.
- If Air Compressor cannot be heard running, check the Air Compressor power source fuse, and wiring to the Air Compressor from the power source and BCM.
- **Sensor Calibration** has not been performed.

Position value is lower than 0% or higher than 100%

- Check the position sensors and linkages for damage.
- Perform **Sensor Calibration**.

Diagnostic Values Guide

Value	Description	Typical Values
BATTERY	Power Supply Voltage to BCM	11.0-14.5V
5V REG	Internal Supply Voltage	5.0V +/-0.1V
PRE	Pressure Sensor Signal Voltages (Left, Right, Inflator)	0.25-2.25V (~0.43V @ 0PSI)
POS	Position Sensor Signal Voltages (Left, Right, Inflator)	Left and Right Signal: 0.25-2.25V Inflator Signal: 0-0.25V
WS	Wheel Speed Sensor Current	~7 or ~14 if fitted, otherwise ~0.
PITCH BOT	Maximum Pitch Angle recorded in "Sensor Calibration"	0° ±3° ~1.5° greater than PITCH TOP
PITCH TOP	Minimum Pitch Angle recorded in "Sensor Calibration"	0° ±3° ~1.5° less than PITCH BOT
ROLL LEFT	Minimum Roll Angle recorded in "Sensor Calibration"	-3° ±5° ~5° less than ROLL RIGHT
ROLL RIGHT	Maximum Roll Angle recorded in "Sensor Calibration"	3° ±5° ~5° greater than ROLL RIGHT
ROLL ZERO	Angle Offset stored in "Set Level Position"	0° ±5°
PITCH ZERO	Angle Offset stored in "Set Level Position"	0° ±5°
LEFT RH MIN	Left Position Minimum recorded in "Sensor Calibration"	2410-3686 ~2000 greater than LEFT RH MAX
LEFT RH MAX	Left Position Maximum recorded in "Sensor Calibration"	410-1687 ~2000 less than LEFT RH MIN
RIGHT RH MIN	Right Position Minimum recorded in "Sensor Calibration"	410-1687 ~2000 less than RIGHT RH MAX
RIGHT RH MAX	Right Position Maximum recorded in "Sensor Calibration"	2410-3686 ~2000 greater than RIGHT RH MIN
LEFT RAW	Current Left Position Sensor Value	Depends on current position, within LEFT RH MIN & MAX.
RIGHT RAW	Current Right Position Sensor Value	Depends on current position, within RIGHT RH MIN & MAX.
PITCH	Current Pitch Angle	0° ±20° depending on ground slope.
ROLL	Current Roll Angle	0° ±20° depending on ground slope.
AT PRESSURE	Atmospheric Pressure	7-14PSI, depending on Altitude
TEMPERATURE	Unit Temperature	~0-10°C above Ambient

Electrical Schematics
Air Control Module Cabling

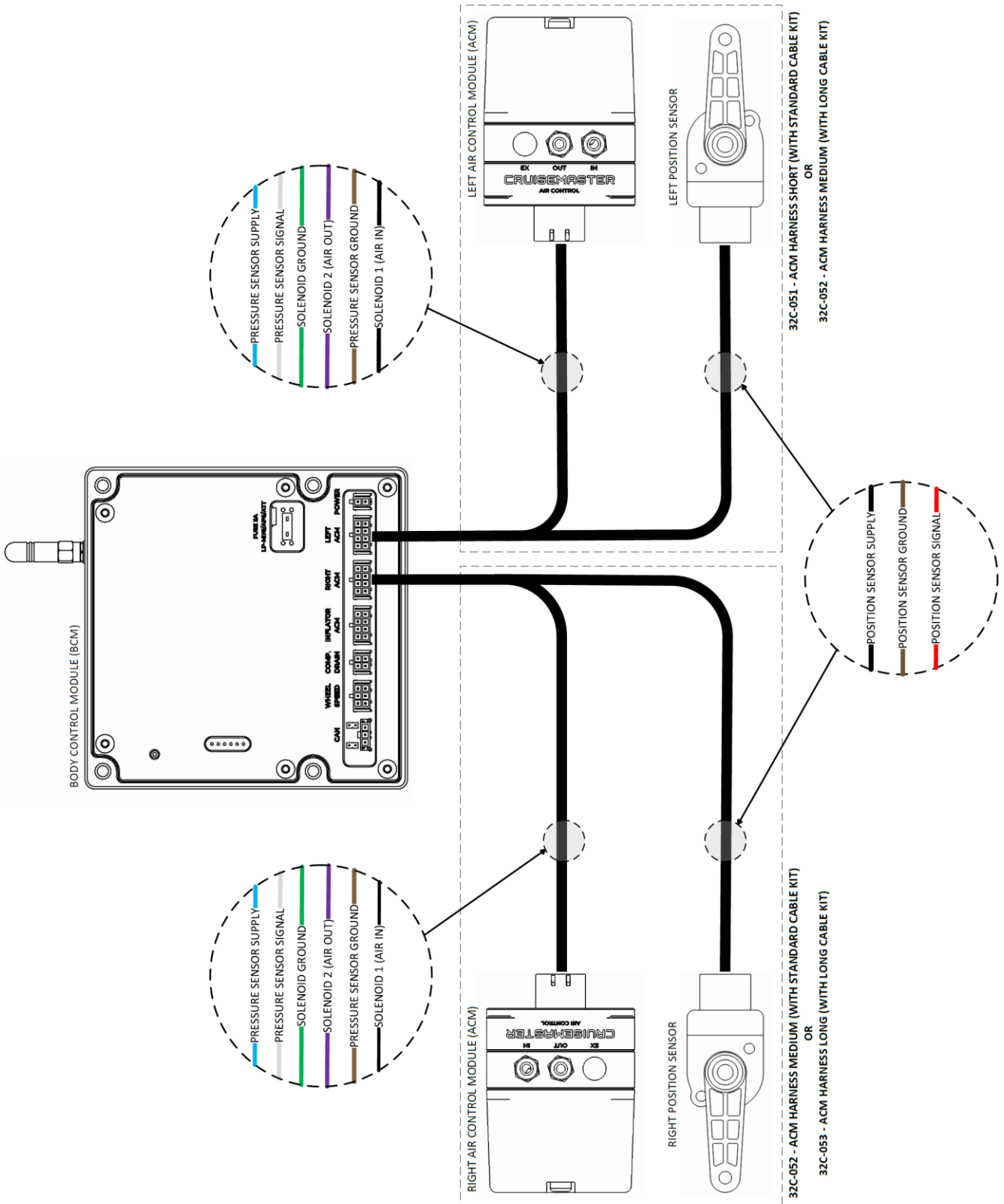

Air System Schematic

